

**SONY**<sup>®</sup>

2-059-372-11(1)

# GRAND WEGA



**LCD Projection TV  
HD-TV  
Operating Instructions**

**KDF-55XS955  
KDF-60XS955**



MEMORY STICK™



**WEGA ENGINE**

**S-master**  
Digital Amplifier

### Owner's Record

The model and serial numbers are located at the rear of the LCD projection TV, below the Sony logo, on the sticker, and also on the TV box (white label). Record these numbers in the spaces provided below. Refer to them whenever you call upon your Sony dealer regarding this product.

Model No. \_\_\_\_\_

Serial No. \_\_\_\_\_

### Contacting Sony

If, after reading the following instructions, you have additional questions related to the use of your Sony TV, Please call one of the following numbers.

Customers in the continental United States contact the Direct Response Center at:

1-800-222-SONY (7669)

Customers in Canada contact the Customer Relations Center at:

1-877-899-SONY (7669)

## WARNING

To prevent fire or shock hazard, do not expose the LCD projection TV to rain or moisture.

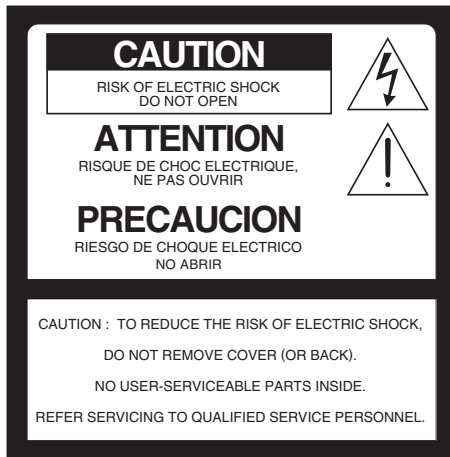

This symbol is intended to alert the user to the presence of uninsulated “dangerous voltage” within the product’s enclosure that may be of sufficient magnitude to constitute a risk of electric shock to persons.



This symbol is intended to alert the user to the presence of important operating and maintenance (servicing) instructions in the literature accompanying the appliance.

## CAUTION

To prevent electric shock, do not use this polarized AC plug with an extension cord, receptacle or other outlet unless the blades can be fully inserted to prevent blade exposure.

## CAUTION

When using TV games, computers, and similar products with your projection TV, keep the brightness and contrast functions at low settings. If a fixed (non-moving) pattern is left on the screen for long periods of time at a high brightness or contrast setting, the image can be permanently imprinted onto the screen. Continuously watching the same program can cause the imprint of station logos onto the TV screen. These types of imprints are not covered by your warranty because they are the result of misuse.

## Note on Caption Vision

This television receiver provides display of television closed captioning in accordance with §15.119 of the FCC rules.

## Note to CATV system installer

This reminder is provided to call the CATV system installer’s attention to Article 820-40 of the NEC that provides guidelines for proper grounding and, in particular, specifies that the cable ground shall be connected to the grounding system of the building, as close to the point of cable entry as practical.

Use of this television receiver for other than private viewing of programs broadcast on UHF, VHF, transmitted by cable companies or satellite for the use of the general public may require authorization from the broadcaster/cable company and/or program owner.

## NOTIFICATION

This equipment has been tested and found to comply with the limits for a Class B digital device pursuant to Part 15 of the FCC Rules. These limits are designed to provide reasonable protection against harmful interference in a residential installation. This equipment generates, uses, and can radiate radio frequency energy and, if not installed and used in accordance with the instructions, may cause harmful interference with radio communications. However, there is no guarantee that interference will not occur in a particular installation. If this equipment does cause harmful interference to radio or television reception, which can be determined by turning the equipment off and on, the user is encouraged to try to correct the interference by one or more of the following measures:

- Reorient or relocate the receiving antennas.
- Increase the separation between the equipment and receiver.
- Connect the equipment into an outlet on a circuit different from that to which the receiver is connected.
- Consult the dealer or an experienced radio/TV technician for help.

You are cautioned that any changes or modifications not expressly approved in this manual could void your warranty and your authority to operate this equipment.

## Safety

- ❑ Operate the LCD projection TV only on 120 V AC.
- ❑ The plug is designed, for safety purposes, to fit into the wall outlet only one way. If you are unable to insert the plug fully into the outlet, contact your dealer.
- ❑ If any liquid or solid object should fall inside the cabinet, unplug the LCD projection TV immediately and have it checked by qualified service personnel before operating it further.
- ❑ If you will not be using the LCD projection TV for several days, disconnect the power by pulling the plug itself. Never pull on the cord.
- ❑ For details concerning safety precautions, see “Important Safeguards” on page 5.

## Installing

- ❑ To prevent internal heat buildup, do not block the ventilation openings.
- ❑ Do not install the LCD projection TV in a hot or humid place, or in a place subject to excessive dust or mechanical vibration.
- ❑ Avoid operating the LCD projection TV at temperature below 41°F (5°C).
- ❑ If the LCD projection TV is transported directly from a cold to a warm location, or if the room temperature changes suddenly, the picture may be blurred or show poor color. In this case, please wait a few hours to let the moisture evaporate before turning on the LCD projection TV.
- ❑ To obtain the best picture, do not expose the screen to direct illumination or direct sunlight. It is recommended to use spot lighting directed down from the ceiling or to cover the windows that face the screen with opaque drapery. It is desirable to install the LCD projection TV in a room where the floor and walls are not of a reflective material.

## Note

This digital television is capable of receiving analog basic, digital basic and digital premium cable television programming by direct connection to a cable system providing such programming. A security card provided by your cable operator is required to view encrypted digital programming. Certain advanced and interactive digital cable services such as video-on-demand, a cable operator’s enhanced program guide and data-enhanced television services may require the use of a set-top box. For more information call your local cable operator.

This television also includes a QAM demodulator which should allow you to receive unscrambled digital cable television programming via subscription service to a cable service provider. Availability of digital cable

television programming in your area depends on the type of programming and signal provided by your cable service provider.

## Trademark Information

CableCARD™ is a trademark of Cable Television Laboratories, Inc.

TruSurround, SRS and the (●)® symbol are trademarks of SRS Labs, Inc. TruSurround technology is incorporated under license from SRS Labs, Inc.

BBE and BBE Symbol are trademarks of BBE Sound, Inc. and are licensed by BBE Sound, Inc. under U.S. Patent No. 4,638,258 and 4,482,866.



Manufactured under license from Dolby Laboratories. Dolby and the double-D symbol are trademarks of

Dolby Laboratories.



This TV incorporates High-Definition Multimedia Interface (HDMI™)

technology. HDMI, the HDMI logo and High-Definition Multimedia Interface are trademarks or registered trademarks of HDMI Licensing LLC.

WEGA, Steady Sound, Digital Reality Creation, CineMotion, BN Smoother, Memory Stick, Memory Stick Duo, Memory Stick PRO, Memory Stick PRO Duo, MagicGate, MID and Twin View are trademarks of Sony Corporation.

## Caution

Use the following Sony appliance only with the following TV STAND. Use with other TV STAND may cause instability and result in possible injury.

SONY APPLIANCE MODEL NO.:

KDF-55XS955

KDF-60XS955

SONY TV STAND MODEL NO.:

SU-GW12



# Important Safeguards

Before using your LCD projection TV, please read these instructions completely, and keep this manual for future reference.

Carefully observe and comply with all warnings, cautions and instructions placed on the set or described in the operating instructions or service manual.

## WARNING

To guard against injury, the following basic safety precautions should be observed in the installation, use and servicing of the set.

## Use

### Power Sources

This set should be operated only from the type of power source indicated on the serial/model plate.

If you are not sure of the type of electrical power supplied to your home, consult your dealer or local power company. For those sets designed to operate from battery power, refer to the operating instructions.



### Grounding or Polarization

This set is equipped with a polarized AC power cord plug (a plug having one blade wider than the other), or with a three-wire grounding type plug (a plug having a third pin for grounding). Follow the instructions below:

### For the set with a polarized AC power cord plug

This plug will fit into the power outlet only one way. This is a safety feature. If you are unable to insert the plug fully into the outlet, try reversing the plug.

If the plug still fails to fit, contact your electrician to have a suitable outlet installed. Do not defeat the safety purpose of the polarized plug by forcing it in.



### For the set with a three-wire grounding type AC plug

This plug will only fit into a grounding-type power outlet. This is a safety feature. If you are unable to insert the plug into the outlet, contact your electrician to have a suitable outlet installed. Do not defeat the safety purpose of the grounding plug.

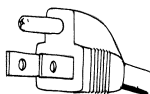

## Overloading

Do not overload wall outlets, extension cords or convenience receptacles beyond their capacity, since this can result in fire or electric shock.

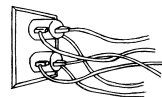

Always turn the set off when it is not being used. When the set is left unattended and unused for long periods of time, unplug it from the wall outlet as a precaution against the possibility of an internal malfunction that could create a fire hazard.



If a snapping or popping sound from a TV set is continuous or frequent while the TV is operating, unplug the TV and consult your dealer or service technician. It is normal for some TV sets to make occasional snapping or popping sounds, particularly when being turned on or off.

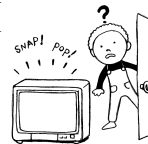

## Object and Liquid Entry

Never push objects of any kind into the set through the cabinet slots as they may touch dangerous voltage points or short out parts that could result in a fire or electric shock. Never spill liquid of any kind on the set.



## Attachments

Do not use attachments not recommended by the manufacturer, as they may cause hazards.

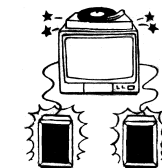

## Cleaning

❑ Clean the rear cover area of the LCD projection TV regularly. Dust in the rear cover area may cause a problem with the cooling system of the LCD projection TV set.

❑ Clean the cabinet of the LCD projection TV with a dry soft cloth. To remove dust from the screen, wipe it gently with a soft cloth. Stubborn stains may be removed with a cloth slightly dampened with solution of mild soap and warm water. Never use strong solvents such as thinner or benzine for cleaning. If the picture becomes dark after using the LCD projection TV for a long period of time, it may be necessary to clean the inside of the LCD projection TV. Consult qualified service personnel.



❑ Unplug the AC power cord when cleaning this unit. If not, it may result in electric shock.

## On contamination on the screen surface

The screen surface has a special coating to reduce reflections. To prevent screen damage, clean the screen as follows:

- ❑ Clean the screen with a soft cloth.
- ❑ To remove hard contamination, use the cloth moistened with a solution of mild detergent and water. Do not spray cleaning solution directly to the TV. It should only be first sprayed to moisten the cleaning cloth.
- ❑ Do not use any type of abrasive pad, alkaline cleaner, acid cleaner, scouring powder, chemical cloth, or solvent such as alcohol, benzene or thinner, as these may scratch the screen's coating.

## Installation

### Water and Moisture

Do not use power-line operated sets near water — for example, near a bathtub, washbowl, kitchen sink, or laundry tub, in a wet basement, or near a swimming pool, etc.



### Accessories

Do not place the set on an unstable cart, stand, table or shelf. The set may fall, causing serious injury to a child or an adult and serious damage to the set. Use only a cart or stand recommended by the manufacturer for the specific model of LCD projection TV. An appliance and cart combination should be moved with care. Quick stops, excessive force, and uneven surfaces may cause the appliance and cart combination to overturn.



### Ventilation

The slots and openings in the cabinet and in the back or bottom are provided for necessary ventilation. To ensure reliable operation of the set, and to protect it from overheating, these slots and openings must never be blocked or covered.

- ❑ Never cover the slots and openings with a cloth or other materials.
- ❑ Never block the slots and openings by placing the set on a bed, sofa, rug or other similar surface.



- ❑ Never place the set in a confined space, such as a bookcase or built-in cabinet, unless proper ventilation is provided.



- ❑ Do not place the set near or over a radiator or heat register, or where it is exposed to direct sunlight.



## Power-Cord Protection

Do not allow anything to rest on or roll over the power cord, and do not place the set where the power cord is subject to wear or abuse.



## Antennas

### Outdoor Antenna Grounding

If an outdoor antenna is installed, follow the precautions below. An outdoor antenna system should not be located in the vicinity of overhead power lines or other electric light or power circuits, or where it can come in contact with such power lines or circuits.

**WHEN INSTALLING AN OUTDOOR ANTENNA SYSTEM, EXTREME CARE SHOULD BE TAKEN TO KEEP FROM CONTACTING SUCH POWER LINES OR CIRCUITS AS CONTACT WITH THEM IS ALMOST INVARIABLY FATAL.**

Be sure the antenna system is grounded so as to provide some protection against voltage surges and built-up static charges.

Section 810 of the National Electrical Code (NEC) in USA and Section 54 of the Canadian Electrical Code in Canada provides information with respect to proper grounding of the mast and supporting structure, grounding of the lead-in wire to an antenna discharge unit, size of grounding conductors, location of antenna discharge unit, connection to grounding electrodes, and requirements for the grounding electrode.

## Antenna Grounding According to the NEC

Refer to section 54-300 of Canadian Electrical Code for Antenna Grounding.

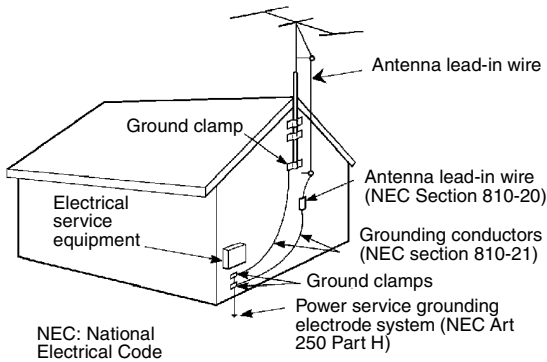

## Lightning

For added protection for this television receiver during a lightning storm, or when it is left unattended and unused for long periods of time, unplug it from the wall outlet and disconnect the antenna. This will prevent damage to the receiver due to lightning and power-line surges.

## Service

### Damage Requiring Service

Do not attempt to service the set by yourself since opening the cabinet may expose you to dangerous voltage or other hazards.



Unplug the set from the wall outlet and refer servicing to qualified service personnel under the following conditions:

- ❑ When the power cord or plug is damaged or frayed.
- ❑ If liquid has been spilled into the set.
- ❑ If the set has been exposed to rain or water.
- ❑ If the set has been subject to excessive shock by being dropped, or the cabinet has been damaged.
- ❑ If the set does not operate normally when following the operating instructions. Adjust only those controls that are specified in the operating instructions. Improper adjustment of other controls may result in damage and will often require extensive work by a qualified technician to restore the set to normal operation.



- ❑ When the set exhibits a distinct change in performance, it indicates a need for service.

## Replacement Parts

When replacement parts are required, be sure the service technician certifies in writing that he has used replacement parts specified by the manufacturer that have the same characteristics as the original parts.

Unauthorized substitutions may result in fire, electric shock or other hazards.

## Safety Check

Upon completion of any service or repairs to the set, ask the service technician to perform routine safety checks (as specified by the manufacturer) to determine that the set is in safe operating condition, and to so certify. When the set reaches the end of its useful life, ask a qualified service technician to dispose of the set.



## For Safety

### Be careful when moving the LCD projection TV

When you place the LCD projection TV in position, be careful not to drop it on your foot or fingers.

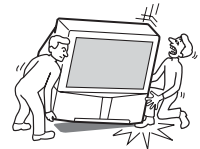

Watch your footing while installing the LCD projection TV.

### Carry the LCD projection TV in the specified manner

If you carry the LCD projection TV in a manner other than the specified manner and without the specified number of persons, it may drop and a serious injury may be caused. Be sure to follow the instructions mentioned below.

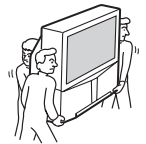

- ❑ Carry the LCD projection TV with the specified number of persons (see page 25).
- ❑ Do not carry the LCD projection TV holding the speaker grill.
- ❑ Hold the LCD projection TV tightly when carrying it.
- ❑ Before carrying the LCD projection TV, disconnect any accessories or cables.

## About the LCD projection TV

Although the LCD projection TV is made with high-precision technology, black dots may appear or bright points of light (red, blue, or green) may appear constantly on the LCD screen. This is a structural property of the LCD panel and is not a defect.

## Installation

- ❑ If direct sunlight or other strong illumination shines on the screen, part of the screen may appear white due to reflections from behind the screen. This is a structural property of the LCD projection TV. Do not expose the screen to direct illumination or direct sunlight.
- ❑ The picture quality may be affected by your viewing position. Sit at least approx. 6.8 ft. (2.1 m) for KDF-55XS955, or sit at least approx. 7 ft. (2.2 m) for KDF-60XS955 away from your LCD projection TV, and within 55° of the vertical and 125° of the horizontal viewing area. If you sit too close to the TV, you may experience eye strain. For the best picture quality, install your LCD projection TV according to “Recommended Viewing Area” on page 27.
- ❑ When installing your LCD projection TV against a wall, keep it at least 4 inches (10 cm) from the wall.
- ❑ Avoid installing the LCD projection TV near a heater, etc.

## Projection lamp

- ❑ Your LCD projection TV uses a projection lamp as its light source. It is time to replace the lamp with a new one (not supplied) when:
    - the lamp replacement indicator on the front panel blinks in red,
    - screen images become dark,
    - no image appears on the display after prolonged use.
  - ❑ In rare instances, the bulb may pop inside the lamp unit, but the lamp unit is designed to contain all of broken glass pieces inside the lamp unit. (See “Replacing the Lamp” on page 16.)
- ❑ When the lamp eventually burns out, you may hear a noticeable pop sound. This is normal and is inherent in this type of lamp.

## Cooling fan

- ❑ This LCD projection TV uses a cooling fan. You may hear the noise of fan running, depending on the placement of your LCD projection TV. The noise may be more noticeable during the night or when the background noise level is low.

## Important Safety Instructions

- 1) Read these instructions.
- 2) Keep these instructions.
- 3) Heed all warnings.
- 4) Follow all instructions.
- 5) Do not use this apparatus near water.
- 6) Clean only with dry cloth.
- 7) Do not block any ventilation openings. Install in accordance with the manufacturer’s instructions.
- 8) Do not install near any heat sources such as radiators, heat registers, stoves, or other apparatus (including amplifiers) that produce heat.
- 9) Do not defeat the safety purpose of the polarized or grounding-type plug. A polarized plug has two blades with one wider than the other. A grounding type plug has two blades and a third grounding prong. The wide blade or the third prong are provided for your safety. If the provided plug does not fit into your outlet, consult an electrician for replacement of the obsolete outlet.
- 10) Protect the power cord from being walked on or pinched particularly at plugs, convenience receptacles, and the point where they exit from the apparatus.
- 11) Only use attachments/accessories specified by the manufacturer.
- 12) Use only with the cart, stand, tripod, bracket, or table specified by the manufacturer, or sold with the apparatus. When a cart is used, use caution when moving the cart/apparatus combination to avoid injury from tip-over. 
- 13) Unplug this apparatus during lightning storms or when unused for long periods of time.
- 14) Refer all servicing to qualified service personnel. Servicing is required when the apparatus has been damaged in any way, such as power-supply cord or plug is damaged, liquid has been spilled or objects have fallen into the apparatus, the apparatus has been exposed to rain or moisture, does not operate normally, or has been dropped.
- 15) Apparatus shall not be exposed to dripping or splashing and no objects filled with liquids, such as vases, shall be placed on the apparatus.

# Contents

## Introducing the Sony LCD Projection TV

Presenting the Sony LCD Projection TV .....	11
Package Contents .....	11
Using This Manual .....	11
Features .....	12
Enjoying Your LCD Projection TV .....	14
Notes on the LCD Projection TV .....	15
Cleaning the Screen Surface .....	15
Replacing the Lamp .....	16

## Setting Up the LCD Projection TV

Overview .....	21
LCD Projection TV Front Panel and Connectors ..	22
Front Panel .....	22
Front and Rear Panel Connectors .....	23
Installing the LCD Projection TV .....	25
Carrying Your LCD Projection TV .....	25
Take Precaution during the Installation .....	26
To Prevent the LCD Projection TV from Falling .....	26
When Installing Your LCD Projection TV Against a Wall .....	26
Recommended Viewing Area .....	27
Basic Connections: Connecting a Cable or	
Antenna .....	28
Cable or Antenna .....	29
Cable and Antenna .....	30
Cable Box and Cable .....	31
Cable Box .....	32
Connecting Optional Equipment .....	33
Making Video Connections .....	34
About Using S VIDEO .....	34
VCR and Cable .....	35
VCR and Cable Box .....	36
Two VCRs for Tape Editing .....	38
Satellite Receiver .....	39
Satellite Receiver with a VCR .....	40
DVD Player with Component Video Connectors .....	42
DVD Player with S VIDEO and Audio Connectors .....	43
Camcorder .....	44
Audio Receiver .....	45
Digital Cable Box .....	46
Digital Satellite Receiver .....	47

Digital Satellite Receiver with HDMI Connector .....	48
Connecting a Device with an Optical IN Connector .....	50
Using the CONTROL S Feature .....	51
Using CableCARD .....	52
About Using CableCARD .....	52
Activating CableCARD Service .....	52
Removing the CableCARD .....	53
Setting Up the LCD Projection TV Channel List ..	54
Using Initial Setup .....	54

## Using the Remote Control

Overview .....	55
Inserting Batteries into the Remote Control .....	55
Button Descriptions .....	56
Programming the Remote Control .....	58
Manufacturer's Codes .....	59
Using Other Equipment with Your LCD Projection TV Remote Control .....	60
Operating a Cable Box .....	60
Operating a Satellite Receiver .....	60
Operating a VCR .....	61
Operating a DVD Player or DVD Changer ..	61
Operating a 5.1ch DVD AV System (SONY DAV) .....	61
Operating a DVD/VCR or HDD/DVD Combo Unit .....	62
Operating an AV Receiver .....	62

## Using the Features

Overview .....	63
Watching TV .....	63
Using the Program Guide .....	64
Displaying the Program Guide .....	64
Using the Guide Menu .....	65
Using the Program Options Menu .....	65
Using Wide Screen Mode .....	66
Changing the Wide Screen Mode for 4:3 Source (Standard definition source) .....	66
Changing the Wide Screen Mode for 16:9 Source (High definition source) .....	67
Using Twin View .....	68
Displaying Twin Pictures .....	68
Activating the Picture .....	68
Changing the Picture Size .....	70

Using Favorite Channels.....	71
Using the Channel Menu .....	71
Using the Favorite Channels Guide .....	72
Using the Freeze Function .....	73

Programming Caption Vision .....	110
Using the Application Menu.....	111
Selecting Application Options .....	111

## Using the Memory Stick Viewer

About Memory Stick .....	75
Features .....	75
Memory Stick Compatibility .....	76
Memory Stick Functionality .....	76
File Compatibility .....	77
Trademark Information .....	77
Inserting and Removing a Memory Stick .....	78
Inserting a Memory Stick .....	78
Inserting the Memory Stick Duo .....	79
Removing a Memory Stick .....	80
Using the Memory Stick Index .....	81
Using the Memory Stick Index .....	82
Viewing Photos.....	83
Photo Controls .....	83
Photo Menu Bar Options .....	84
Using Zoom and Pan.....	85
Using Rotate .....	85
Playing Movies .....	86
Movie Controls .....	86
Movie Menu Bar Options .....	87
Memory Stick Index Menu Bar Options.....	88
Slide Show Menu Options .....	88
Folder Menu Options .....	89
Memory Stick Menu .....	89
Notes on Using Memory Stick Media .....	90
About DCF File Names .....	90
Memory Stick Precautions.....	91

## Using the Menus

Overview.....	93
Using the Video Menu .....	94
Selecting Video Options .....	94
Using the Audio Menu.....	98
Selecting Audio Options.....	98
Using the Screen Menu.....	100
Selecting Screen Options .....	100
Using the Channel Menu .....	102
Selecting Channel Options.....	102
Using the Parent Menu .....	104
Selecting Parent Options.....	104
Viewing Blocked Programs .....	105
Selecting Custom Rating Options.....	106
Using the Setup Menu.....	108
Selecting Setup Options.....	108

## Other Information

Overview.....	113
Glossary .....	114
Contacting Sony.....	115
Troubleshooting.....	115
Twin View .....	115
Remote Control.....	116
CableCARD.....	116
Memory Stick .....	117
Video.....	119
Audio .....	120
Channels .....	120
General.....	121
Flashing Indicators on the Front of the TV .....	122
Specifications.....	123
Optional Accessories .....	125

## Index

Index.....	127
------------	-----



# Introducing the Sony LCD Projection TV

## Presenting the Sony LCD Projection TV

Thank you for purchasing the Sony LCD projection TV.  
This manual is for models KDF-55XS955 and KDF-60XS955.

### Package Contents

Along with your new LCD projection TV, the packing box contains a remote control and two AA (R6) batteries. These items are all you need to set up and use the TV.

### Using This Manual

We recommend that you carefully review the contents of the following five sections in the order shown to ensure that you fully understand the operation of your new LCD projection TV.

#### **1** Setting Up the LCD Projection TV

This section guides you through your initial setup. It shows you how to install your LCD projection TV, to connect your new components and to connect the antenna and cable.

#### **2** Using the Remote Control

This section shows you how to begin using your new LCD projection TV. It also shows you how to use your remote control functions.

#### **3** Using the Features

This section provides information on using the Program Guide, Wide Screen Mode, Twin View, Favorite Channels and Freeze Function.

#### **4** Using the Memory Stick Viewer

This section shows you how to use the Memory Stick Viewer to view files that are stored on Memory Stick media, such as photographs and movies.

#### **5** Using the Menus

This section teaches you how to access on-screen menus and adjust your LCD projection TV settings.

Instructions in this manual are written for the remote control. Similar controls are also found on the LCD projection TV console.

## Features

Some of the features that you will enjoy with your new LCD projection TV include:

- ❑ **WEGA Engine™**: Delivers superb picture quality from any video source by minimizing the signal deterioration caused by digital-to-analog conversion and stabilizing the signal processing. This engine features unique Sony technology, including:
  - The first step in the digital processing system, Composite Component Processor (CCP-X), which enhances input signal-to-noise ratio by chroma decoder digital processing.
  - **DRC® (Digital Reality Creation)-MF V1**: Unlike conventional line doublers, the DRC Multifunction feature replaces the signal's NTSC waveform with the near-HD equivalent by digital mapping processing. The DRC Palette option lets you customize the level of detail (Reality) and smoothness (Clarity) to create up to three custom palettes.
  - **Multi-Image Driver (MID™-XU)**: Allows you to watch two programs side by side (Twin View®). You can watch pictures from two different sources (1080i, 720p, 480p and 480i) simultaneously. Only the left Twin View window can display 1080i, 720p and 480p sources.
- ❑ **Integrated HDTV**: You can watch digital television programs and enjoy the improved audio/video quality offered by these programs.
- ❑ **S-master Full Digital Amplifier**: Delivers superb clear dialog and reproduces the original sound quality while minimizing any sound fragmentation or jitter noise.
- ❑ **BN Smoother™**: Reduces the block noise caused by digital video encoding and decoding process.
- ❑ **CineMotion®**: Using the reverse 3-2 pull down technology, the CineMotion feature provides smoother picture movement when playing back movies or other video sources on film.
- ❑ **Twin View®**: Using Multi-Image Driver (MID™-XV), Twin View allows you to watch two programs side by side with the ability to zoom in on one picture and listen to the program in the selected window. You can watch pictures from two different sources (1080i, 720p, 480p or 480i) simultaneously.
- ❑ **Memory Stick® Viewer**: Allows you to view digital photos (JPEG) and movies (MPEG1) from Memory Stick media on your LCD projection TV screen.
- ❑ **Parental Control**: V-Chip technology allows parents to block unsuitable programming from younger viewers.

- ❑ **CableCARD™ slot:** Provides cable subscribers with access to digitally encrypted cable channels — without the need for a set-top box — that will enable you to receive not only standard definition but also high definition television. The CableCARD, which is provided by your cable TV company, is inserted into the TV's rear panel CableCARD slot. After the service is activated with your cable TV company, the card replaces the need for a separate set-top box. (Check with your cable TV company about CableCARD service details, limitations, pricing, and availability. For more information about CableCARD in this manual, see page 52.)
- ❑ **Component Video Inputs:** Offers the best video quality for DVD (480p, 480i) and digital set-top box (1080i, 720p, 480p, 480i) connections.
- ❑ **S VIDEO Inputs:** Provides a high-quality image from connected equipment.
- ❑ **Favorite Channel Preview:** Allows you to preview up to sixteen favorite channels without leaving the current channel.
- ❑ **Wide Screen Mode:** Allows you to watch 4:3 normal broadcasts in wide screen mode (16:9 aspect ratio).
- ❑ **Steady Sound®:** Equalizes volume levels so there is consistent output between programs and commercials.
- ❑ **HDMI (High-Definition Multimedia Interface):** Provides an uncompressed, all-digital audio/video interface between this TV and any HDMI-equipped audio/video component, such as a set top box, DVD player, and A/V receiver. HDMI supports enhanced, or high-definition video, plus multi-channel digital audio.

## Enjoying Your LCD Projection TV

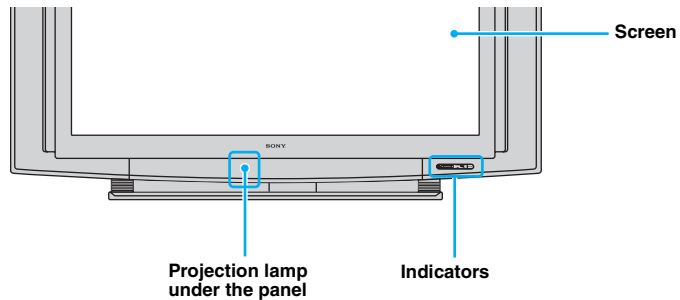

### Indicators

The indicators show the current status of your LCD projection TV.

### Screen

To minimize reflection, the screen's surface has a special coating. Read the instructions "Cleaning the Screen Surface" on page 15 carefully before cleaning.

Inappropriate cleaning methods could damage the screen's finish.

### Projection lamp

Your LCD projection TV uses a projection lamp as its light source. The projection lamp is located under the Control Panel Cover as noted in the diagram above. Note the following:

- ❑ After turning on your LCD projection TV, it may take a while before the picture appears (1 minute or less).
- ❑ When the projection lamp wears out, the screen goes dark. Replace the lamp with a new Sony XL-2200 replacement lamp (not supplied).

- 🔧 After replacing the lamp, be sure to attach the lamp cover securely; otherwise, your LCD projection TV will not turn on. For details on lamp replacement, see "Replacing the Lamp" on page 16.
- 🔧 The light emitted from the lamp is quite bright when your LCD projection TV is in use. To avoid eye discomfort or injury, do not look into the housing when the power is on.

## Notes on the LCD Projection TV

### To enjoy clear pictures

- ❑ Prevent sunlight or other light sources from shining directly onto the screen.
- ❑ The screen surface is easily scratched. Do not rub, touch, or tap it with a sharp or abrasive object (see “Cleaning the Screen Surface” below).

### On moisture condensation

- ❑ If your LCD projection TV is moved directly from a cold to a warm location, is placed in a humid room, or if the room temperature changes suddenly, the picture may blur or show poor color. This is caused by moisture condensation on the lenses inside. If this happens, leave the power on to help the moisture evaporate. When the condensation has evaporated, the picture of your LCD projection TV will return to normal.

### When not using the LCD Projection TV for a long period of time

- ❑ Turn off the main power on the front of your LCD projection TV before going to sleep or going out. Unplug the AC power cord from the outlet if you anticipate not using the LCD projection TV for more than a week.

### When turning off the power

- ❑ The fan will continue to operate for about two minutes. Allow several minutes before unplugging from the outlet or switching the breaker off.

### Before carrying the LCD Projection TV

- ❑ Before carrying, unplug the power cord and disconnect all cables. See page 25 for instructions on how to carry your LCD projection TV.

## Cleaning the Screen Surface

To remove dust on the screen, wipe with soft cloth.

- ✎ Do not use any type of abrasive pad, alkaline cleaner, scouring powder, window cleaners or solvent such as alcohol or benzene. Using these types of products may damage the screen.
- ✎ To clean the screen, use the cloth lightly moistened with a mild detergent and water solution. Use gentle pressure when cleaning.

## Replacing the Lamp

The projection lamp, which illuminates the picture, has a limited life.

If the screen becomes dark, the color looks unusual, or the LAMP indicator on the front of the LCD projection TV flashes, it is time to replace the lamp with a new one (not supplied).



### WARNING

Electric appliances can cause fire or high temperature, resulting in injury or death. Be sure to follow the instructions below.

- ❑ Use a Sony XL-2200 replacement lamp (not supplied) for replacement. Use of any other lamp may damage the LCD projection TV.
- ❑ Do not remove the lamp for any purpose other than replacement. Doing so may cause injury or fire.
- ❑ Before replacing the lamp, turn the power off on the main unit. Wait several minutes, then unplug the power cord. (The cooling fan will continue to blow for about two minutes after turning the power off.)
- ❑ Allow the lamp to cool down completely before removing it. The surface of the lamp remains extremely hot for at least 30 minutes after the power has been turned off.
- ❑ Do not put flammable materials and metal objects inside the lamp receptacle of the LCD projection TV after removing the lamp. Doing so may cause fire or electrical shock.
- ❑ To avoid being burned, do not touch the lamp receptacle once the lamp has been removed.
- ❑ Mount the new lamp securely. Failure to do so may cause a fire or the screen to go dark.
- ❑ Do not touch the glass of the new lamp with your fingers.

 Avoid touching the front glass of a new lamp as this may reduce picture quality or lamp life.

### The used lamp

For customers in the United States:

This product contains mercury. Disposal of this product may be regulated if sold in the United States. For disposal or recycling information, please contact your local authorities or the Electronics Industries Alliance (<http://www.eiae.org>).

- ❑ Do not leave the used lamp near flammable materials or within the reach of children.
- ❑ Do not pour water onto the used lamp or put any object inside the lamp. Doing so may cause the lamp to burst.



- 1 Turn off the power on the main unit. Wait several minutes, then unplug the power cord.  
(The cooling fan will continue to operate for about two minutes after turning the power off.)

- 2 Wait at least 30 minutes after unplugging the power cord to allow the lamp to cool down before replacing it.  
Take the new lamp out of the box.

 Don't shake the lamp. Vibration can damage the lamp or shorten its life.

 Avoid touching the front glass of a new lamp or the glass of the lamp receptacle. This may reduce picture quality or lamp life.

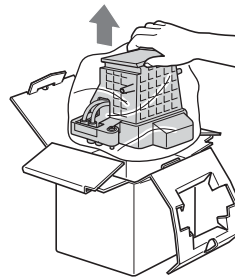

- 3 Remove the Front Panel Cover.

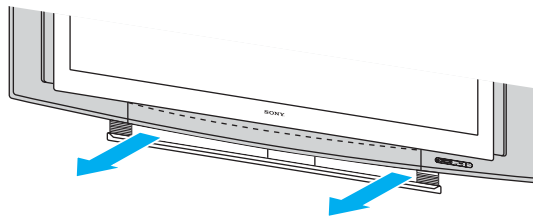

 Hold beneath both sides of the cover, and pull forward to release it.

- 4 Pull out the lamp.

Loosen the screw on the lamp cover with a coin or similar object to remove it, slide the knob to left, and then pull out the lamp cover.

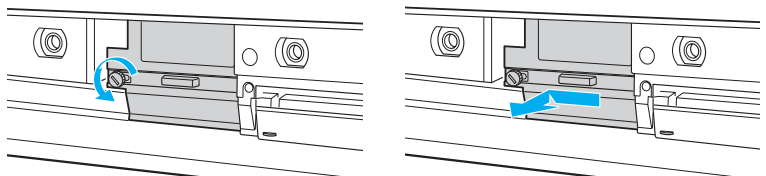

(Continued)

Loosen the screw that holds the lamp, then pull out the lamp.

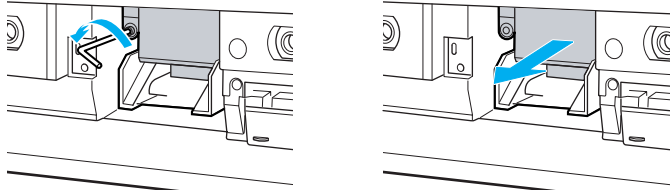

- ⚠ The lamp is very hot immediately after use. Never touch the front glass of the lamp or the surrounding parts.
- ⚠ After it has cooled, place the used lamp into the empty box of the replacement lamp. Never put the used lamp into a plastic bag while the lamp is hot.

## 5 Reattach the lamp.

Place back the new lamp and tighten the screw.

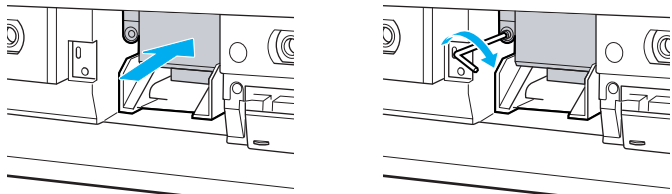

Replace the lamp cover, slide the knob to right till the ▲/▼ mark matches, and then tighten the screw.

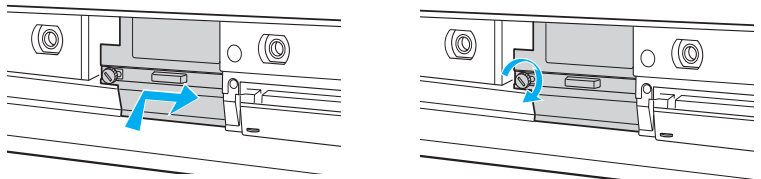

- ⚠ If the lamp cover screw is inserted incorrectly, the lamp may not operate properly. In such a case, remove the screw, insert it correctly and then tighten the screw completely.
- ⚠ If the lamp cover is not reattached securely, the self-diagnostic function may be triggered and the POWER/STANDBY indicator flashes three times (see page 122).

- 6 Reattach the Front Panel Cover securely.

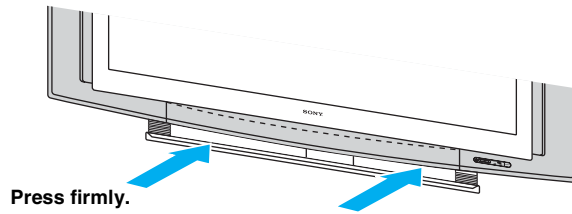

- ✎ Consult your Sony dealer for a Sony XL-2200 replacement lamp.
- ✎ Take great care when replacing the lamp or plugging in/unplugging the connecting cords. Rough handling may cause the LCD projection TV to fall, damaging the TV, the TV stand and/or the floor.



# Setting Up the LCD Projection TV

## Overview

This chapter includes illustrated instructions for setting up your LCD projection TV.

<i>Topic</i>	<i>Page(s)</i>
LCD Projection TV Front Panel and Connectors	22
Installing the LCD Projection TV	25
Basic Connections: Connecting a Cable or Antenna	28
Connecting Optional Equipment	33
VCR and Cable	35
VCR and Cable Box	36
Two VCRs for Tape Editing	38
Satellite Receiver	39
Satellite Receiver with a VCR	40
DVD Player with Component Video Connectors	42
DVD Player with S VIDEO and Audio Connectors	43
Camcorder	44
Audio Receiver	45
Digital Cable Box	46
Digital Satellite Receiver	47
Digital Satellite Receiver with HDMI Connector	48
Connecting a Device with an Optical IN Connector	50
Using the Control S Feature	51
Using CableCARD	52
Setting Up the LCD Projection TV Channel List	54

## LCD Projection TV Front Panel and Connectors

### Front Panel

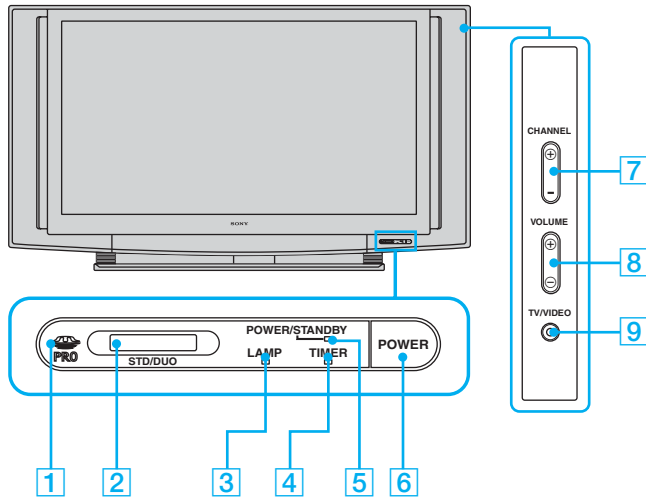

Item	Description
1 Memory Stick indicator	When the Memory Stick indicator is lit, indicates that the Memory Stick is being read. (Do not remove the Memory Stick when the indicator is lit.)
2 Memory Stick slot	For inserting Memory Stick media to view on your LCD projection TV. For details, See “Inserting and Removing a Memory Stick” on page 78.
3 LAMP LED	Lights up in red when the lamp for the light source has burned out. For details, see “Replacing the Lamp” on page 16.
4 TIMER LED	When lit, indicates one of the timers is set. When the timer is set, this LED will remain lit even if the TV set is turned off. For details, see page 122.
5 POWER/STANDBY LED	Lights up in green when the TV set is turned on. When in standby mode, the LED lights up in red. The LED does not light up when the main power is turned off. If the LED blinks continuously, this may indicate the display unit needs servicing (see “Contacting Sony” on page 115).
6 POWER	Press to turn on/off the LCD projection TV. The <b>POWER</b> button has a built-in Infrared (IR) Receiver that receives IR signals from the remote control.
7 CHANNEL +/-	Press to scan through channels.
8 VOLUME +/-	Press to adjust the volume.
9 TV/VIDEO	Press to select between the TV’s tuner and other video equipment inputs.



## Front and Rear Panel Connectors

Front Panel of LCD projection TV

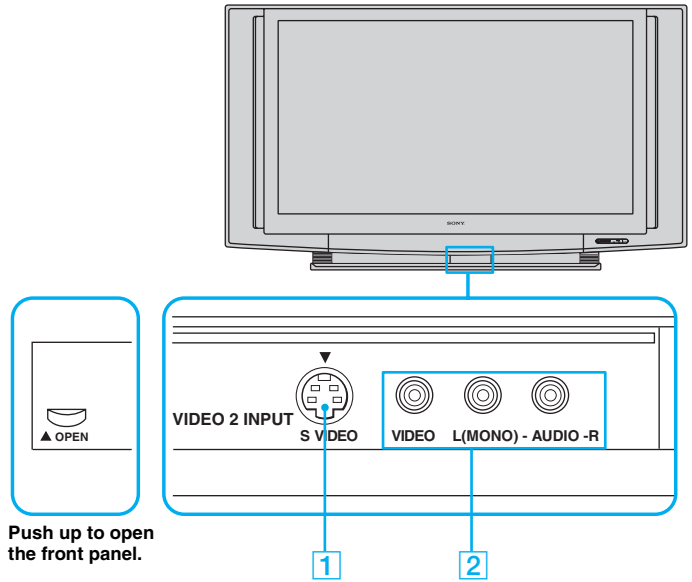

Front panel connectors are under the Control Panel Cover. To open and close the cover, refer to page 18 and 19.

Connection	Description
1 S VIDEO (Front and rear)	Connects to the S VIDEO OUT jack of your VCR or other S VIDEO-equipped video component. Provides better picture quality than the VHF/UHF jacks or the Video IN jack.
2 VIDEO/ L(MONO)-AUDIO-R (Front and rear)	Connects to the audio and video OUT jacks on your VCR or other video component. A fourth video input (VIDEO 2) is located on the front panel of the LCD projection TV.
3 HD/DVD IN (1080i/ 720p/480p/480i)	Connects to your DVD player's or digital set-top box's component video (Y, PB, PR) and audio (L/R) jacks.
4 CONTROL S IN/OUT	To control other Sony equipment with the LCD projection TV's remote control, connect the CONTROL S IN jack of the equipment to the CONTROL S OUT jack on the LCD projection TV with the CONTROL S cable.  To control the LCD projection TV with the remote control of another Sony product, connect the CONTROL S OUT jack of the equipment to the CONTROL S IN jack on the LCD projection TV with the CONTROL S cable.
5 AUDIO OUT (VAR/FIX) L/R	Connects to the left and right audio inputs of your audio or video component.  🔇 AUDIO OUT jacks are operable only when the TV's Speaker is set to Off.

(Continued)

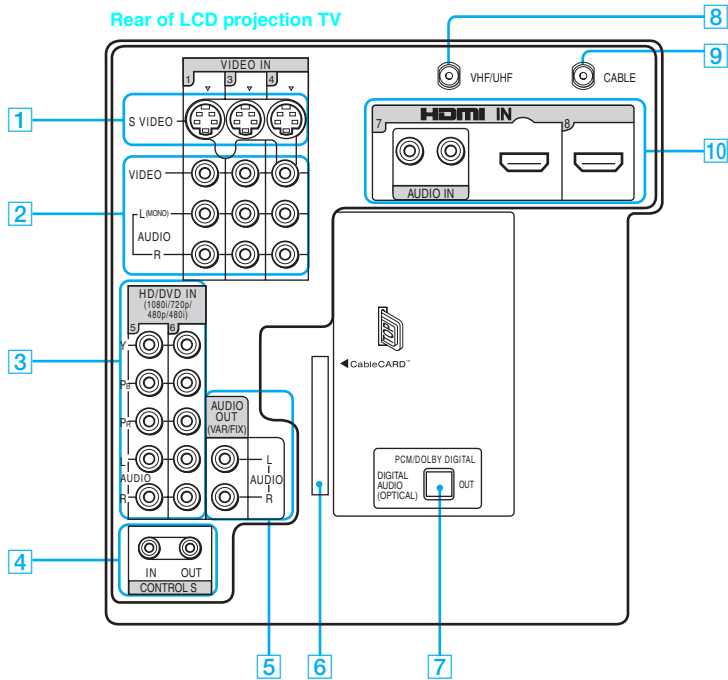

Connection	Description
6 CableCARD slot	CableCARD provides cable subscribers with access to secure, digitally encrypted cable channels - without the need for a set-top box - that will enable you to receive not only standard definition but also high definition television. For more information, see page 52.
7 DIGITAL AUDIO (OPTICAL) OUT (PCM/DOLBY* DIGITAL)	Connects to the optical audio input of a digital audio component that is PCM/Dolby digital compatible.
8 VHF/UHF	Connects to your VHF/UHF antenna or cable box output jack.
9 CABLE	Connects to your cable signal. This CABLE input jack, in conjunction with the VHF/UHF input jack, lets you set up your LCD projection TV to switch between scrambled channels (coming through a cable box) and unscrambled cable channels. For details, see page 31.
10 HDMI (VIDEO 7 IN and VIDEO 8 IN)	HDMI (High-Definition Multimedia Interface) provides an uncompressed, all-digital audio/video interface between this TV and any HDMI-equipped audio/video component, such as a set-top box, DVD player, and A/V receiver. HDMI supports enhanced, or high-definition video, plus two-channel digital audio.

\* Manufactured under license from Dolby Laboratories.  
 “Dolby” and the double-D symbol are trademarks of Dolby Laboratories.

## Installing the LCD Projection TV

### Carrying Your LCD Projection TV

Carrying the LCD projection TV requires at least two people. Do not hold by the pedestal or the Front Panel Cover of the LCD projection TV. Doing so may cause these parts to break off.



When moving the LCD projection TV, place one hand in the hole on the lower portion of the TV while grasping the top with the other hand, as shown in the illustration below.

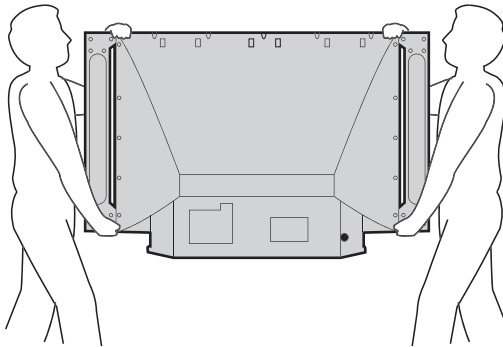

---

**Take Precaution during the Installation**

To ensure the safety of children and the LCD projection TV, keep children away from the TV during installation. Climbing on or pushing the LCD projection TV or its stand may cause it to fall.

---

**To Prevent the LCD Projection TV from Falling**

As a protective measure, secure the LCD projection TV as follows.

**Using the LCD projection TV stand with support belts**

- Sony strongly recommends using the TV stand designed for your LCD projection TV SU-GW12 (not supplied).

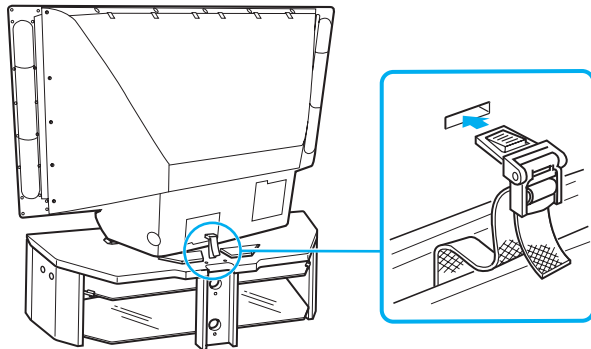

---

**When Installing Your LCD Projection TV Against a Wall**

Keep your LCD projection TV at least 4 inches (10 cm) away from the wall to provide proper ventilation.

## Recommended Viewing Area

Your viewing position may affect the picture quality.

For the best picture quality, install your LCD projection TV within the areas shown below.

Model	Viewing distance
KDF-55XS955	min. 6.8 ft. (approx. 2.1 m)
KDF-60XS955	min. 7 ft. (approx. 2.2 m)

### Horizontal Viewing Area

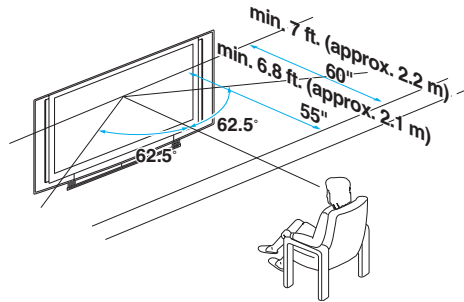

### Vertical Viewing Area

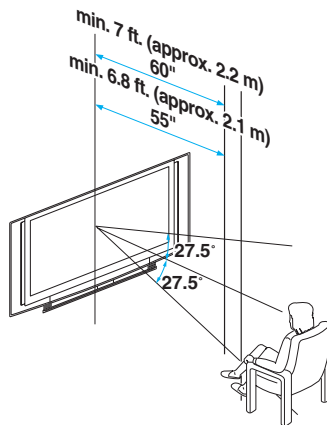

## Basic Connections: Connecting a Cable or Antenna

The way in which you connect your LCD projection TV will vary, depending on how your home receives a signal (cable, cable box, antenna) and whether or not you plan to connect a VCR.

<b><i>If You Are Connecting</i></b>	<b><i>See Page</i></b>
<b><i>Cable or Antenna</i></b>	<b>29</b>
<input type="checkbox"/> No cable box or VCR	
<b><i>Cable and Antenna</i></b>	<b>30</b>
<input type="checkbox"/> No cable box or VCR	
<b><i>Cable Box and Cable</i></b>	<b>31</b>
<input type="checkbox"/> Cable box unscrambles only some channels (usually premium channels)	
<input type="checkbox"/> No VCR	
<b><i>Cable Box</i></b>	<b>32</b>
<input type="checkbox"/> Cable box unscrambles all channels	
<input type="checkbox"/> No VCR	

### **If you are connecting a VCR**

- See the connections described on pages 35 and 36.



## Cable or Antenna

For best results, use one of the following connections if you are connecting a cable or an antenna and you:

- ❑ Do not need a cable box to unscramble channels. (If you have a cable box, see pages 31 and 32.)
- ❑ Do not intend to connect a VCR. (If you have a VCR, see pages 35 and 36.)

The connection you choose depends on the cable type you have in your home, as described below.

### 75-ohm coaxial cable (usually found in newer homes)

#### Cable Type

#### Connect As Shown

VHF Only or  
combined  
VHF/UHF

75-ohm coaxial  
cable

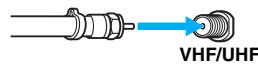

Rear of LCD  
Projection TV  
VHF/UHF

Cable

75-ohm coaxial  
cable

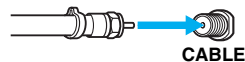

Rear of LCD  
Projection TV  
CABLE

### 300-ohm twin lead cable (usually found in older homes)

#### Cable Type

#### Connect As Shown

VHF Only or  
UHF Only or  
combined  
VHF/UHF

300-ohm twin lead cable

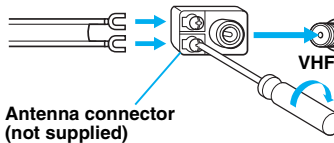

Rear of LCD Projection TV  
VHF/UHF

Antenna connector  
(not supplied)

### 75-ohm coaxial and 300-ohm twin lead cable (found in some homes)

#### Cable Type

#### Connect As Shown

VHF and UHF

75-ohm coaxial cable

U/V mixer  
(not supplied)

300-ohm twin lead cable

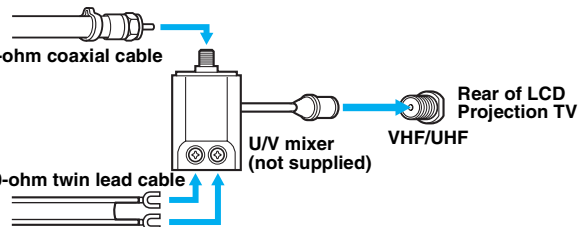

Rear of LCD  
Projection TV  
VHF/UHF

## Cable and Antenna

### For best results, use this connection if you:

- ❑ Have a cable and an antenna.  
(This is convenient if you are using a separate rooftop antenna to receive additional channels that are not provided by your cable TV company.)
- ❑ Do not have a cable box or VCR. (If you have a cable box, see pages 31 and 32. If you have a VCR, see pages 35 and 36.)

### Antenna and CATV cable

Cable Type	Connect As Shown
------------	------------------

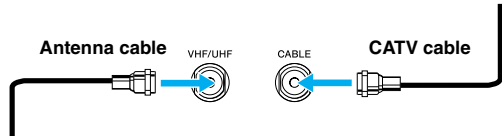
Cable TV (CATV) and Antenna	
-----------------------------	--

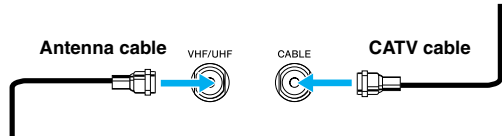

### Notes on Using This Connection

To Do This ...	Do This ...
----------------	-------------

Switch the LCD projection TV's input between the cable and antenna	Press <b>ANT</b> to switch back and forth between the LCD projection TV's VHF/UHF and CABLE inputs.
--	---

- 🔧 For optimum picture quality, a 75-ohm coaxial cable antenna connection is highly recommended. Radio waves and other interference can easily affect a 300-ohm twin lead cable, resulting in signal deterioration. If you use a 300-ohm twin lead cable, keep it as far away as possible from the LCD projection TV.
- 🔧 Do not use an indoor antenna, which is especially susceptible to radio noise.

## Cable Box and Cable

Before connecting a cable box, see "Using CableCARD" on page 52.

### For best results, use this connection if:

- ❑ Your cable company scrambles some channels, such as premium channels (which requires you to use a cable box), but does not scramble all channels.
- ❑ You do not have a VCR. (If you have a VCR, see pages 35 and 36.)

### With this connection you can:

- ❑ Use the LCD projection TV's remote control to change channels coming through the cable box to the LCD projection TV's VHF/UHF input jack. (You must first program the remote control for your specific cable box; see "Programming the Remote Control" on page 58.)
- ❑ Use the LCD projection TV's remote control to change channels coming directly into the LCD projection TV's CABLE input. (The LCD projection TV's tuner provides a better signal than the cable box.)
- ❑ Use all the dual picture features for unscrambled channels coming directly into the LCD projection TV's CABLE input jack.

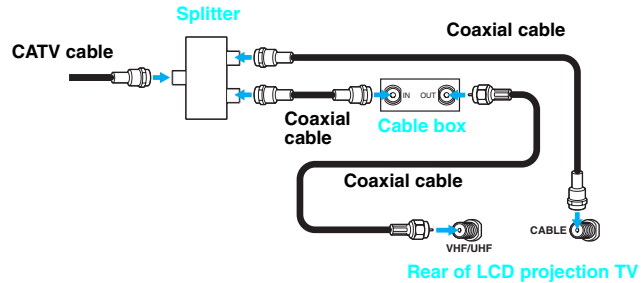

This connection will allow you to take advantage of viewing the pictures in Dual Picture Features such as Twin View, Freeze, etc.

## Notes on Using This Connection

To Do This ...	Do This ...
Use the cable box	Tune the LCD projection TV to the channel the cable box is set to (usually channel 3 or 4) and then use the cable box to switch channels.
Set up the LCD projection TV remote control to operate the cable box	Program the remote control. See "Programming the Remote Control" on page 58.
Activate the remote control to operate the cable box	Press <b>SAT/CABLE FUNCTION</b> once, and the <b>SAT/CABLE</b> indicator lights up.
Prevent the accidental switching of TV channels	When using the cable box, the LCD projection TV must stay on the channel the cable box is set to (usually channel 3 or 4). You can use the LCD projection TV's Channel Fix feature to lock in a specific channel. For details, see "Using the Channel Menu" on page 102.
Switch the LCD projection TV's input between the cable box and cable	Press <b>ANT</b> to switch back and forth between the LCD projection TV's VHF/UHF (scrambled channels) and CABLE (unscrambled) inputs.

## Cable Box

Before connecting a cable box, see "Using CableCARD" on page 52.

### For best results, use this connection if:

- ❑ Your cable company scrambles all channels, which requires you to use a cable box.
- ❑ You do not have a VCR. (If you have a VCR, see pages 35 and 36.)

### With this connection you can:

- ❑ Use the LCD projection TV's remote control to change channels coming through the cable box to the LCD projection TV's VHF/UHF jack. (You must first program the remote control for your specific cable box.)

 With this connection, all channels come into the LCD projection TV through your cable box and only one unscrambled signal is sent to the LCD projection TV, so you cannot use the dual picture features. If some of your channels are scrambled, but others are not, consider using the "Cable Box and Cable" connection on page 31 instead.

### To connect the cable box

- 1** Connect the CATV cable to the cable box's input jack.
- 2** Use a coaxial cable to connect the cable box's output jack to the LCD projection TV's VHF/UHF jack.
- 3** Run Auto Program, as described in "Setting Up the LCD Projection TV Channel List" on pages 54.

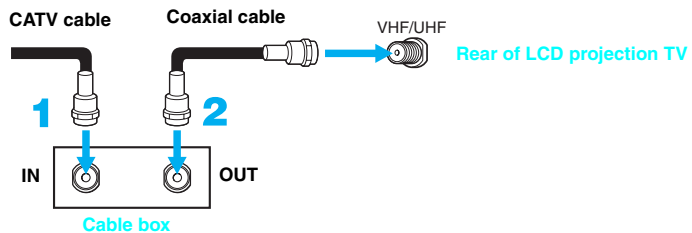

## Notes on Using This Connection

To do this...	Do This ...
Use the cable box	Tune the LCD projection TV to the channel the cable box is set to (usually channel 3 or 4) and then use the cable box to switch channels.
Set up the LCD projection TV remote control to operate the cable box	Program the remote control. See "Programming the Remote Control" on page 58.
Activate the remote control to operate the cable box	Press <b>SAT/CABLE FUNCTION</b> once, and the <b>SAT/CABLE</b> indicator lights up.
Prevent the accidental switching of TV channels	When using the cable box, the LCD projection TV must stay on the channel the cable box is set to (usually channel 3 or 4). You can use the LCD projection TV's Channel Fix feature to lock in a specific channel. For details, see "Using the Channel Menu" on page 102.





## Connecting Optional Equipment

Use the directions in this section to connect the following optional equipment:

<i><b>If You Are Connecting</b></i>	<i><b>See Page</b></i>
Making Video Connections	<b>34</b>
About Using S VIDEO	<b>34</b>
VCR and Cable	<b>35</b>
VCR and Cable Box	<b>36</b>
Two VCRs for Tape Editing	<b>38</b>
Satellite Receiver	<b>39</b>
Satellite Receiver with a VCR	<b>40</b>
DVD Player with Component Video Connectors	<b>42</b>
DVD Player with S VIDEO and Audio Connectors	<b>43</b>
Camcorder	<b>44</b>
Audio Receiver	<b>45</b>
Digital Cable Box	<b>46</b>
Digital Satellite Receiver	<b>47</b>
Digital Satellite Receiver with HDMI Connector	<b>48</b>
Connecting a Device with an Optical IN Connector	<b>50</b>
Using the CONTROL S Feature	<b>51</b>
Using CableCARD	<b>52</b>

## Making Video Connections

Your TV includes several types of video inputs. When connecting your TV, use the inputs that are available on your components that provide the best video performance, as described below.

Best Video Performance	<b>Connector Type</b>
↑	 HDMI (High-Definition Multimedia Interface)
	 Component video
	 S VIDEO
	 Composite video
	 RF/Coaxial

## About Using S VIDEO



If the optional equipment you are connecting has an S VIDEO jack (shown at left), you can use an S VIDEO cable for improved picture quality (compared to an A/V cable). Because S VIDEO carries only the video signal, you also need to connect audio cables for sound, as shown below.

### Example of an S VIDEO Connection

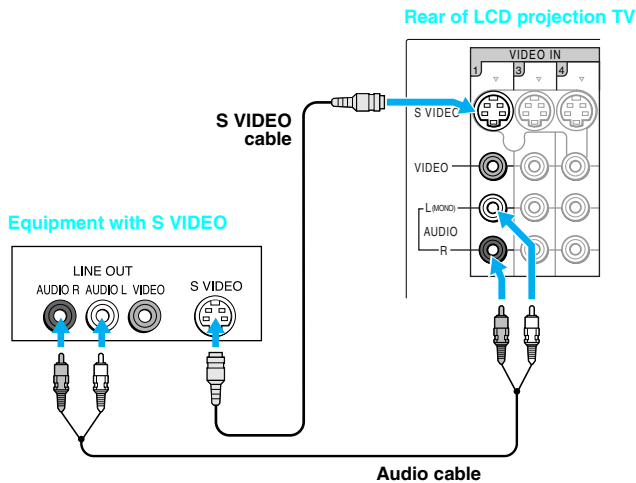

Cables are often color-coded to connectors. Connect red to red, white to white, etc.

## VCR and Cable

Use this hookup if:

- ❑ You have cable TV that does not require a cable box.

**Disconnect all power sources before making any connections.**

- 1** Connect the coaxial connector from your cable service to the VCR's IN jack.
- 2** Using a coaxial cable, connect the VCR's OUT jack to the LCD projection TV's CABLE jack.
- 3** Using A/V and S VIDEO cables, connect the VCR's AUDIO and S VIDEO OUT jacks to the LCD projection TV's AUDIO and S VIDEO IN jacks.

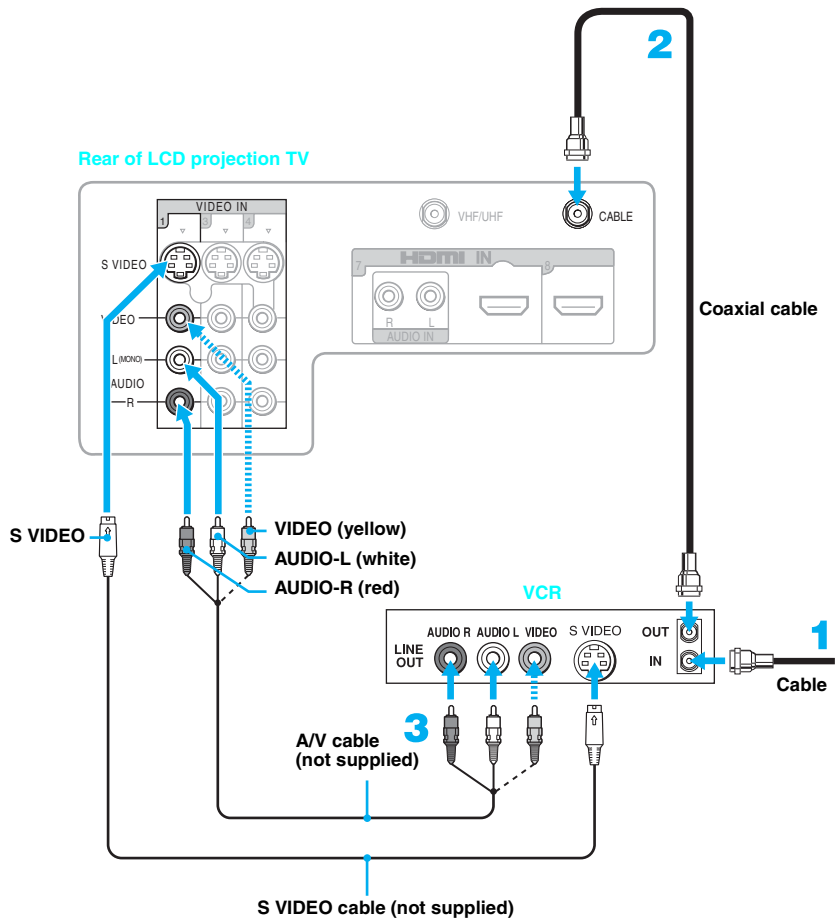

 If your VCR is not equipped with S VIDEO, use a VIDEO cable (yellow) instead of the S VIDEO cable.

## VCR and Cable Box

Before connecting a cable box, see "Using CableCARD" on page 52.

Use this hookup if:

- ❑ Your cable TV company scrambles some channels, but not all of them (pay channels vs. regular cable channels) and you need to use a cable box.
- ❑ You want to enjoy the Twin View feature.

With this setup you can:

- ❑ Use the LCD projection TV's remote control to change channels on your cable box when the signal is scrambled. To program your Sony remote control to operate your cable box, see "Programming the Remote Control" on page 58.
- ❑ Use the LCD projection TV's remote control to change channels on your LCD projection TV when the signal is not scrambled. Your LCD projection TV's tuner provides a better signal than the cable box.
- ❑ Use the Twin View feature. (When all channels are routed through your cable box, only one signal is sent to the LCD projection TV, so you cannot use the Twin View feature.)

### Disconnect all power sources before making any connections.

- 1** Connect the CATV cable to the single (input) jack of the splitter.
- 2** Using a coaxial cable, connect one of the splitter's two output jacks to the LCD projection TV's CABLE jack.
- 3** Using a coaxial cable, connect the splitter's other output jack to the cable box's input jack.
- 4** Using a coaxial cable, connect the cable box's output jack to the VCR's RF input jack.
- 5** Using an A/V cable, connect the cable box's A/V output jacks to the LCD projection TV's A/V input jacks.
- 6** Using an A/V and S VIDEO cables, connect the VCR's AUDIO and S VIDEO OUT jacks to the LCD projection TV's AUDIO and S VIDEO IN input jacks.
- 7** Using a coaxial cable, connect the VCR's RF output jack to the LCD projection TV's VHF/UHF jack.
- 8** Run Auto Program, as described in "Setting Up the LCD Projection TV Channel List" on page 54.

 To view scrambled channels, tune the LCD projection TV to the channel the cable box is set to (usually channel 3 or 4) and then use the cable box to switch channels.



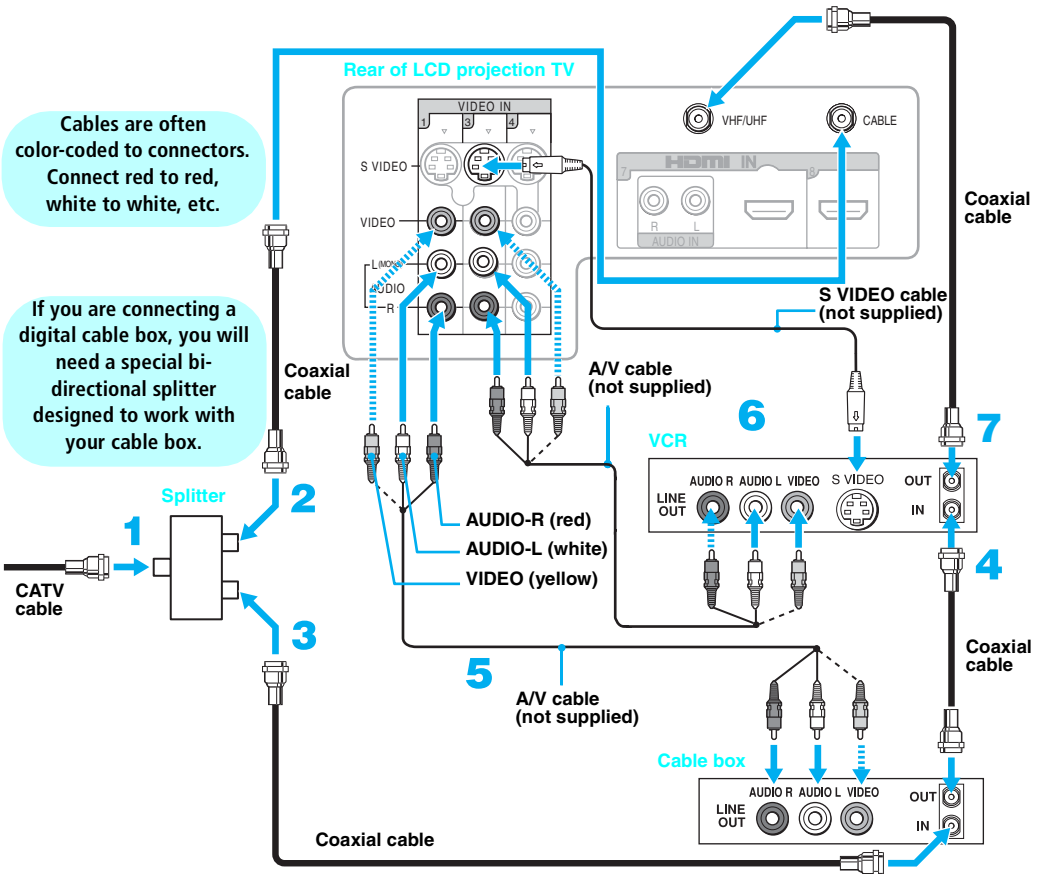

Cables are often color-coded to connectors. Connect red to red, white to white, etc.

If you are connecting a digital cable box, you will need a special bi-directional splitter designed to work with your cable box.

- ✎ If your VCR is not equipped with S VIDEO, use a VIDEO cable (yellow) instead of the S VIDEO cable.
- ✎ You will not be able to change channels on the VCR. Tune the LCD projection TV to the channel the cable box is set to and then use the cable box to switch channels.
- ✎ Pressing ANT on the remote control switches between the channels coming in through the cable box (unscrambled) and those coming directly to the LCD projection TV (scrambled).

## Two VCRs for Tape Editing



Using S VIDEO jacks?  
See page 34.

If you connect two VCRs, you can record from one VCR to the other while using your LCD projection TV to monitor what is being recorded.

**Disconnect all power sources before making any connections.**

- 1** Using A/V cables, connect the playback VCR's AUDIO and VIDEO OUT jacks to the recording VCR's AUDIO and VIDEO IN jacks.
- 2** Using A/V cables, connect the recording VCR's AUDIO and VIDEO OUT jacks to the LCD projection TV's AUDIO and VIDEO IN jacks.

Cables are often color-coded to connectors. Connect red to red, white to white, etc.

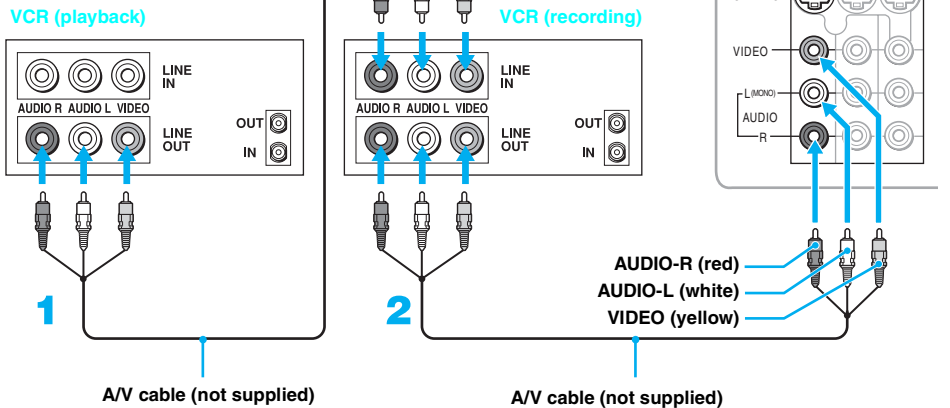

- To perform tape editing, set the LCD projection TV to the video input intended for playback by pressing TV/VIDEO on the remote control.
- You may need to change the video input on your VCR. Consult your VCR's operating manual for instructions.
- If your VCRs have S VIDEO jacks: For best picture quality, use an S VIDEO connection instead of the yellow video cable on your combined A/V cable. Using an S VIDEO cable, connect the playback VCR's S VIDEO OUT jack to the recording VCR's S VIDEO IN jack. S VIDEO does not provide audio, so audio cables must be connected to provide sound.
- You cannot record signals from equipment connected to the Y, P<sub>B</sub>, P<sub>R</sub> input.

## Satellite Receiver

Disconnect all power sources before making any connections.

- 1 Connect the satellite antenna cable to the satellite receiver's SATELLITE IN jack.
- 2 Using A/V and S VIDEO cables, connect the satellite receiver's AUDIO and S VIDEO OUT jacks to the LCD projection TV's AUDIO and S VIDEO IN jacks.
- 3 Using a coaxial cable, connect your cable to the LCD projection TV's CABLE jack, or your antenna to the LCD projection TV's VHF/UHF jack.

 If your satellite receiver is not equipped with S VIDEO, use a VIDEO cable (yellow) instead of the S VIDEO cable.

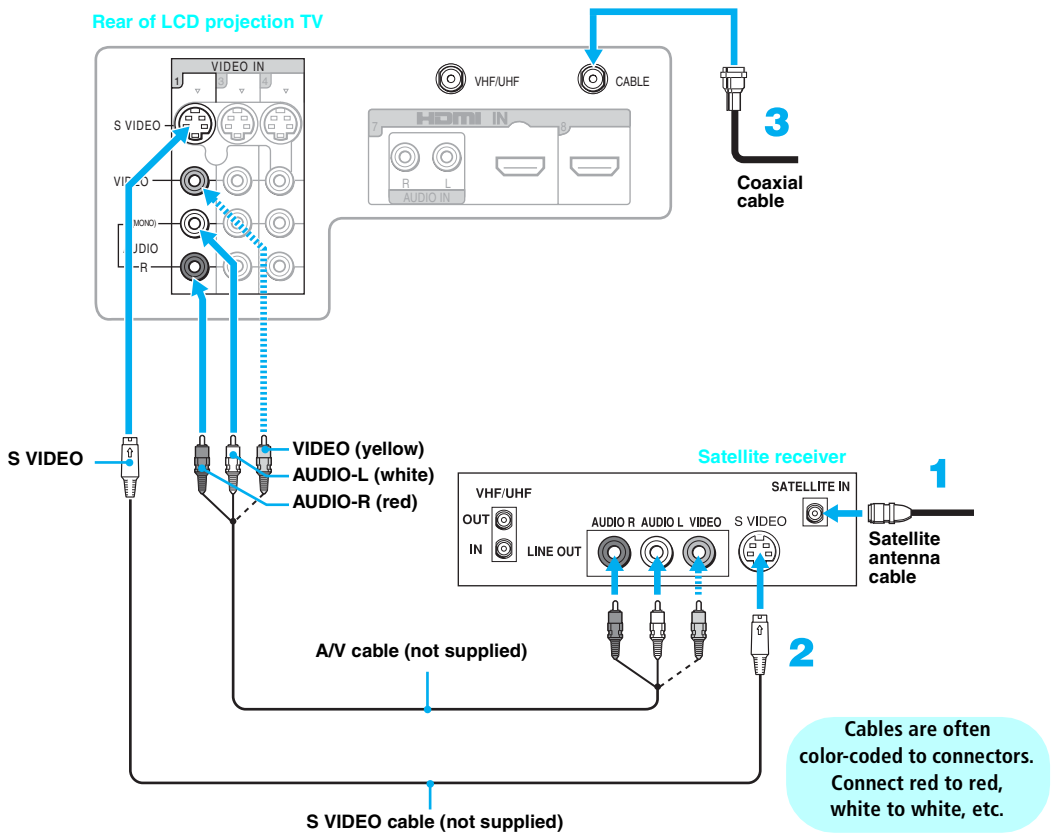

---

**Satellite Receiver  
with a VCR**

**Disconnect all power sources before making any connections.**

- 1** Connect the CATV cable to the single (input) jack of the splitter.
- 2** Using a coaxial cable, connect one of the splitter's two output jacks to the LCD projection TV's CABLE jack.
- 3** Using a coaxial cable, connect the splitter's other output jack to the satellite receiver's VHF/UHF IN jack.
- 4** Connect the satellite antenna cable to the satellite receiver's SATELLITE IN jack.
- 5** Using a coaxial cable, connect the satellite receiver's VHF/UHF OUT jack to the VCR's VHF/UHF IN jack.
- 6** Using A/V and S VIDEO cables, connect the satellite receiver's AUDIO and S VIDEO OUT jacks to the VCR's AUDIO and S VIDEO IN jacks.
- 7** Using A/V and S VIDEO cables, connect the VCR's AUDIO and S VIDEO OUT jacks to the LCD projection TV's AUDIO and S VIDEO IN jacks.
- 8** Run Auto Program, as described in "Setting Up the LCD Projection TV Channel List" on page 54.

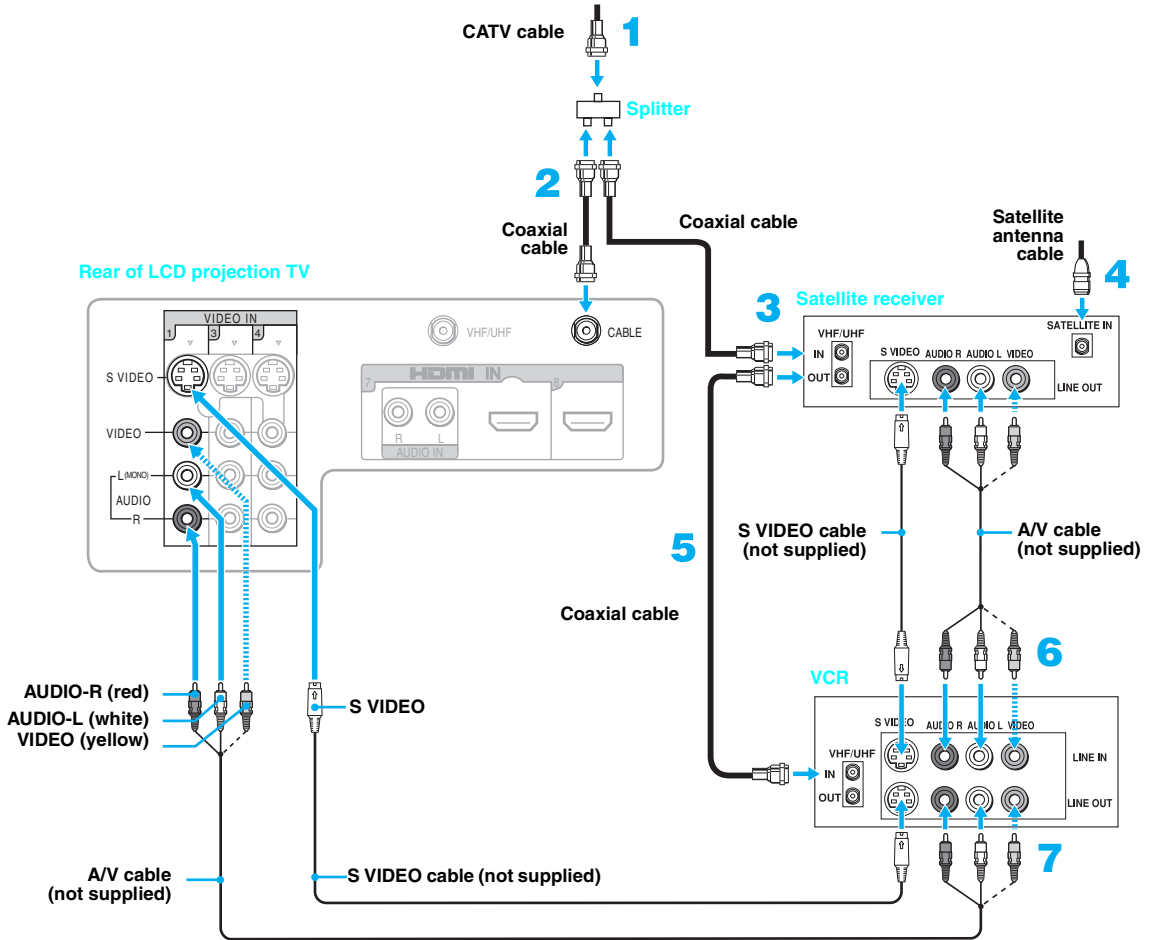

Cables are often color-coded to connectors. Connect red to red, white to white, etc.

- 🔧 Be sure your VCR's video input is set correctly. Consult your VCR's operating manual for instructions.
- 🔧 Use TV/VIDEO to select
  - VIDEO 1 to watch satellite TV or the VCR (your VCR must be turned on).
- 🔧 If your VCR or satellite receiver is not equipped with S VIDEO, use a VIDEO cable (yellow) instead of the S VIDEO cable.

## DVD Player with Component Video Connectors

Use this hookup if:

- Your DVD player has component (Y, B-Y, R-Y) jacks.

**Disconnect all power sources before making any connections.**

- 1 Using a component video cable, connect the DVD player's Y, B-Y and R-Y jacks to the LCD projection TV's Y, PB and PR jacks. Use the HD/DVD IN 5 or 6 connection.

 The Y, B-Y and R-Y jacks on your DVD player are sometimes labeled Y, C<sub>B</sub> and C<sub>R</sub>, or Y, P<sub>B</sub> and P<sub>R</sub>. If so, connect the cables to like colors.

- 2 Using an audio cable, connect the DVD player's AUDIO OUT jacks to the LCD projection TV's AUDIO IN jacks. Be sure to use the same row of inputs that you used for the video connection (HD/DVD IN 5 or 6).

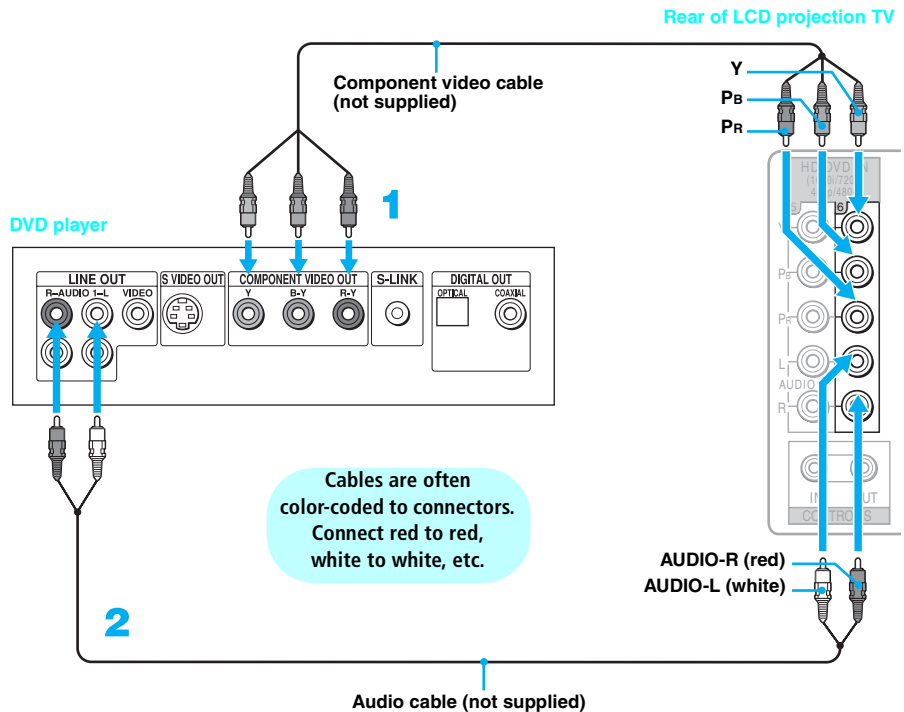

 To take advantage of the Wide Mode, set the DVD player's aspect ratio to 16:9. For details, refer to the operating instructions supplied with your DVD player.

## DVD Player with S VIDEO and Audio Connectors

Use this hookup if:

- Your DVD player does not have component (Y, B-Y, R-Y) jacks.

**Disconnect all power sources before making any connections.**

- 1 Using an audio cable, connect the DVD player's AUDIO OUT jacks to the LCD projection TV's AUDIO IN jacks.
- 2 Using a S VIDEO cable, connect the DVD player's S VIDEO jack to the LCD projection TV's S VIDEO jack.

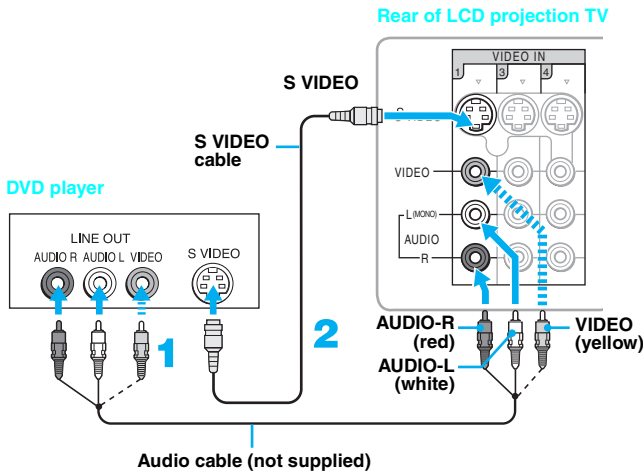

- 🔧 If your DVD player is not equipped with S VIDEO, use a VIDEO cable (yellow) instead of the S VIDEO cable.
- 🔧 To watch the DVD player, press TV/VIDEO repeatedly to select the DVD input (VIDEO 1 in the illustration). If you have a non-Sony DVD player, and want to set up the TV remote control to operate the DVD player you must program the remote control. See "Programming the Remote Control" on page 58.
- 🔧 To control DVD functions with the TV remote control, see "Operating a DVD Player or DVD Changer" on page 61.
- 🔧 Label video inputs to easily identify equipment connected to the TV. See the instructions for setting up Video Labels on page 109.

## Camcorder

**Disconnect all power sources before making any connections.**

For easy connection of the camcorder, the LCD projection TV has front audio and video inputs (shown below). However, if you prefer, you can also connect the camcorder to the LCD projection TV's rear AUDIO and S VIDEO IN jacks.

Using A/V and S VIDEO cables, connect the camcorder's audio and S VIDEO OUT jacks to the LCD projection TV's AUDIO and S VIDEO IN jacks.

- ✎ If you have a mono camcorder, connect its left audio output to the LCD projection TV's AUDIO L (MONO) jack.
- ✎ If your camcorder is not equipped with S VIDEO, use a VIDEO cable (yellow) instead of the S VIDEO cable.

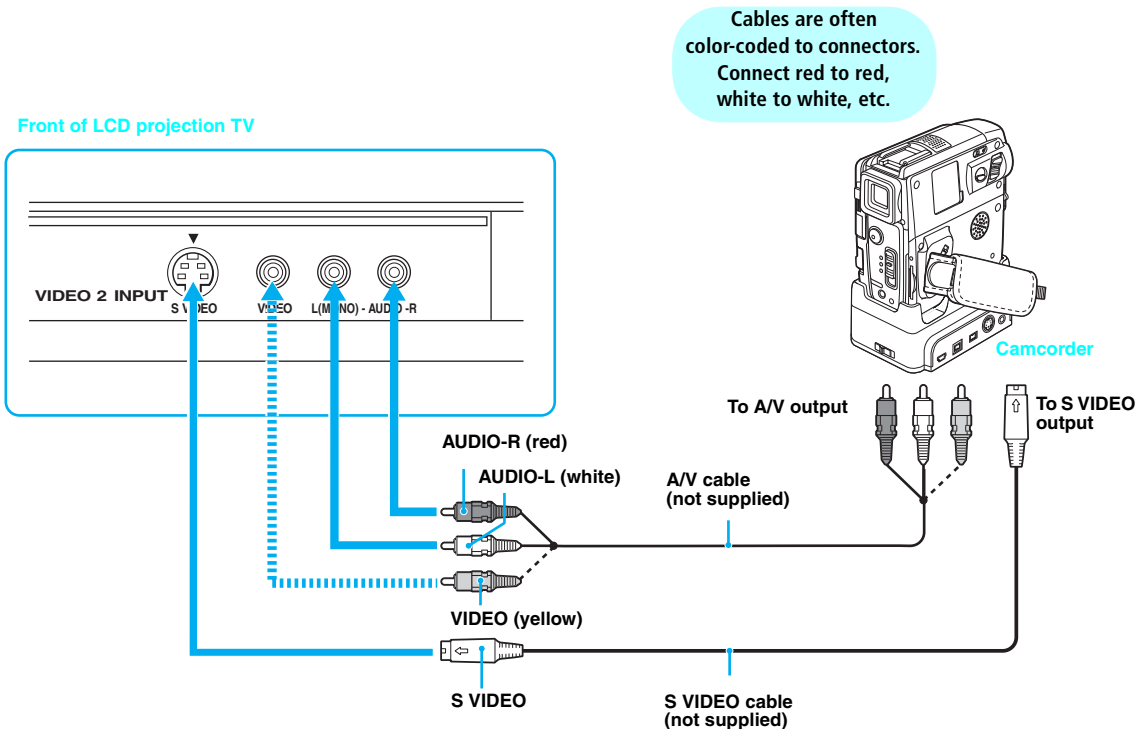



## Audio Receiver

For improved sound quality, you may want to play the TV's audio through your stereo system (see page 99).

**Disconnect all power sources before making any connections.**

Using A/V cables, connect the LCD projection TV's AUDIO OUT (VAR/FIX) jacks to the audio receiver's audio LINE IN jacks.

 AUDIO OUT jacks are operable only when the TV's Speaker is set to Off.

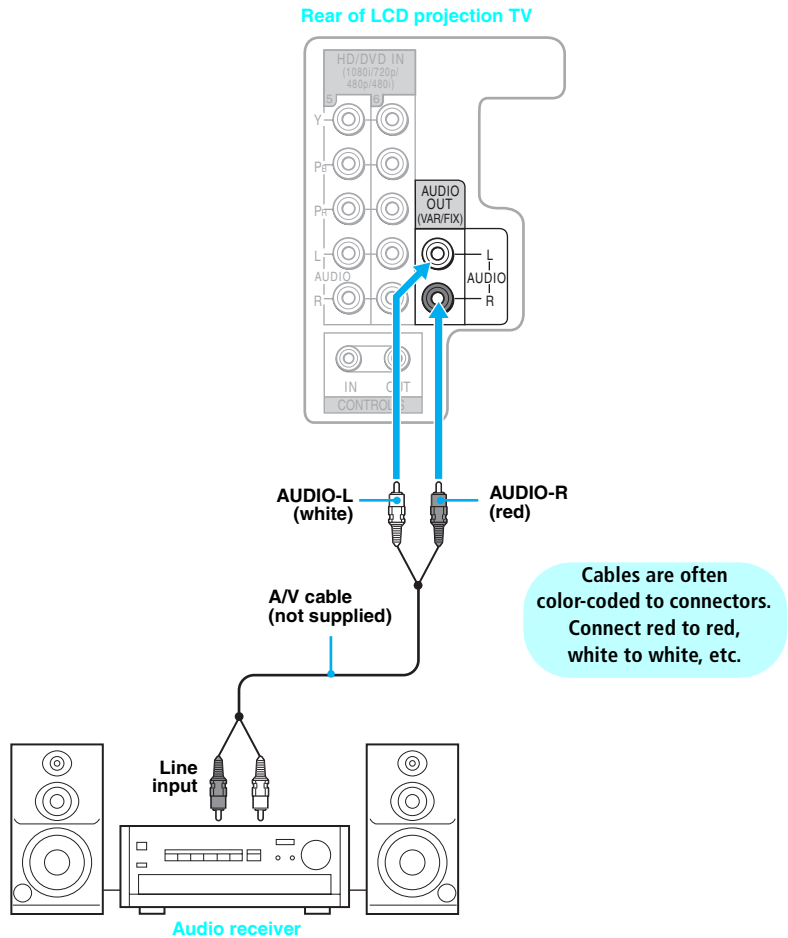

## Digital Cable Box

Disconnect all power sources before making any connections.

**1** Using a component video cable, connect the digital cable box's Y, P<sub>B</sub> and P<sub>R</sub> jacks to the LCD projection TV's Y, P<sub>B</sub> and P<sub>R</sub> jacks. Use the HD/DVD IN 5 or 6 connection.

 Component video (Y, P<sub>B</sub>, P<sub>R</sub>) connection is necessary to view 480p, 720p, and 1080i formats. Note that this TV displays all format types of picture in a resolution of 1368 dots x 768 lines.

**2** Using an audio cable, connect the digital cable box's AUDIO OUT jacks to the LCD projection TV's AUDIO IN jacks.

 The Y, P<sub>B</sub> and P<sub>R</sub> jacks do not provide audio, so audio cables must be connected to provide sound.

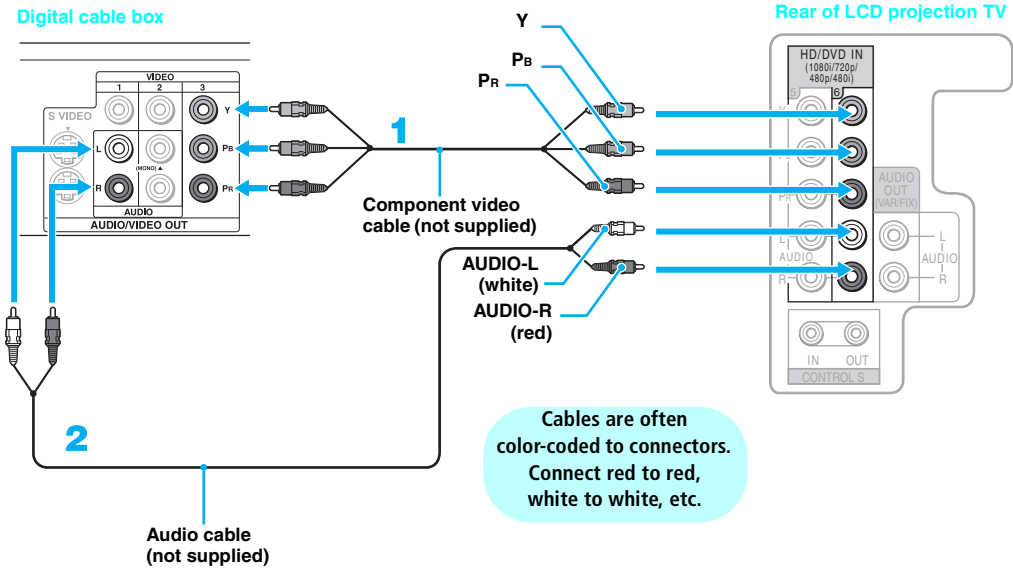

## Digital Satellite Receiver

Disconnect all power sources before making any connections.

**1** Using a component video cable, connect the digital satellite receiver's Y, P<sub>B</sub> and P<sub>R</sub> jacks to the LCD projection TV's Y, P<sub>B</sub> and P<sub>R</sub> jacks. Use the HD/DVD IN 5 or 6 connection.

 Component video (Y, P<sub>B</sub>, P<sub>R</sub>) connection is necessary to view 480p, 720p, and 1080i formats. Note that this TV displays all format types of picture in a resolution of 1368 dots x 768 lines.

**2** Using an audio cable, connect the digital satellite receiver's AUDIO OUT jacks to the LCD projection TV's AUDIO IN jacks.

 The Y, P<sub>B</sub> and P<sub>R</sub> jacks do not provide audio, so audio cables must be connected to provide sound.

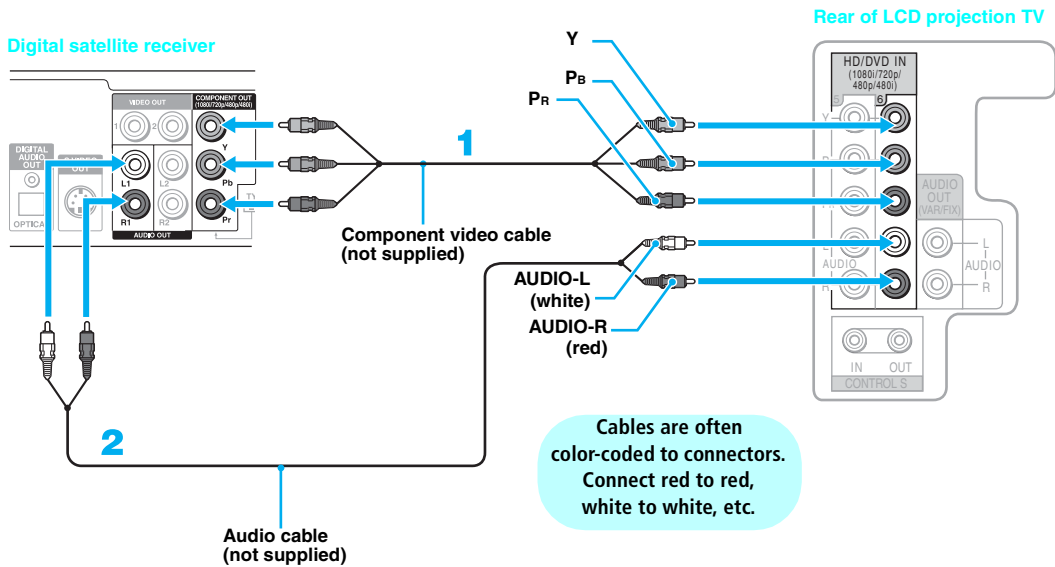

## Digital Satellite Receiver with HDMI Connector

Use this hookup if:

- Your digital satellite receiver has a High-Definition Multimedia Interface (HDMI).

**Disconnect all power sources before making any connections:**

Using an HDMI cable (not supplied), connect the digital satellite receiver's HDMI OUT jack to the LCD projection TV's HDMI IN jack.

Use the HDMI IN 7 input or 8 input connection.

 The HDMI jack provides both video and audio signals, so it is not necessary to connect the audio cable.

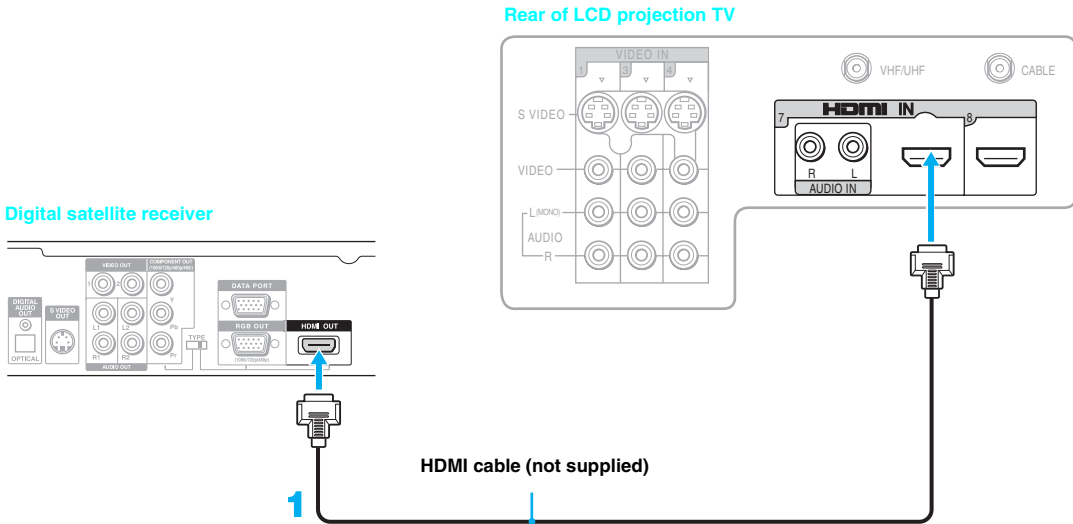

**When connecting to the Digital Satellite Receiver's DVI-HDTV connector**

If you are connecting to a digital satellite receiver with DVI-HDTV output, you can connect to the LCD projection TV's HDMI IN jack by using an HDMI-to-DVI cable or an adaptor (both not supplied).

- 1 Using a HDMI cable (not supplied), connect the digital satellite receiver's DVI-HDTV OUT jack to the LCD projection TV's HDMI IN jack.

Use the HDMI IN 7 input or 8 input connection.

- 2 Using an audio cable, connect the digital satellite receiver's AUDIO OUT jacks to the LCD projection TV's AUDIO IN jacks.

 The DVI-HDTV VIDEO jack does not provide audio, so audio cables must be connected to provide sound when an HDMI to DVI-HDTV adapter (not supplied) is used.

Cables are often color-coded to connectors. Connect red to red, white to white, etc.

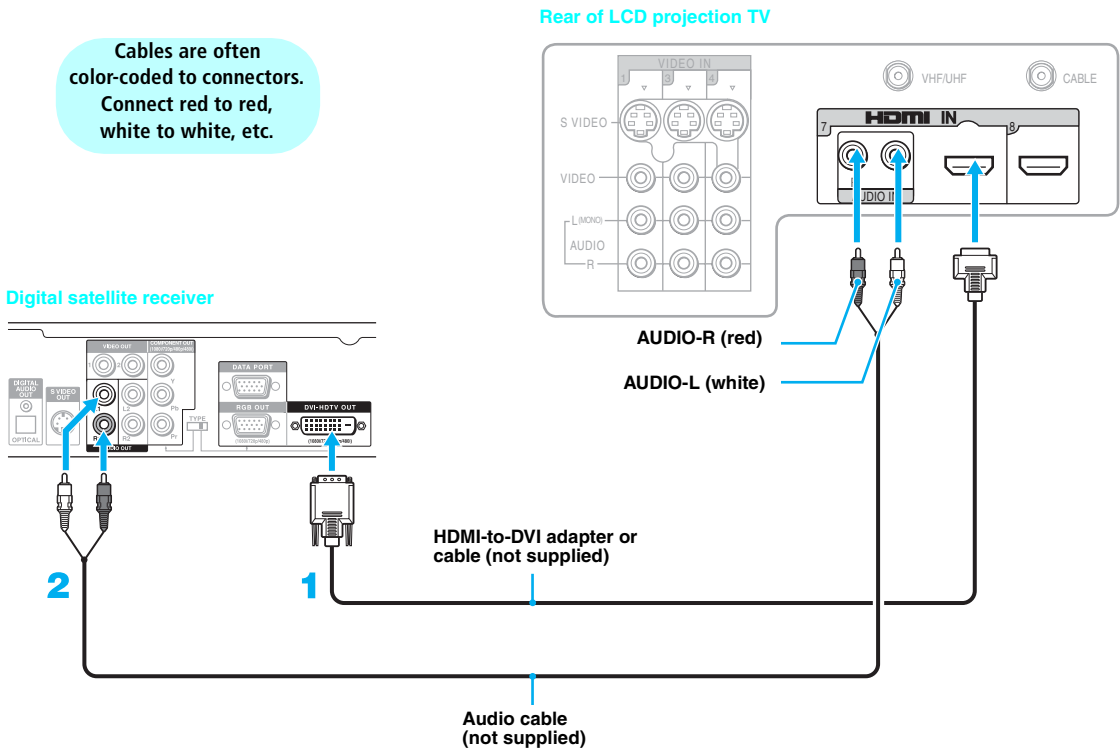

## Connecting a Device with an Optical IN Connector

You can use the LCD Projection TV's DIGITAL AUDIO (OPTICAL) OUT jack to connect a digital audio device that is PCM/Dolby digital compatible, such as an audio amplifier.

Using an optical audio cable, connect the device's OPTICAL IN jack to the LCD projection TV's DIGITAL AUDIO (OPTICAL) OUT jack.

Rear of LCD projection TV

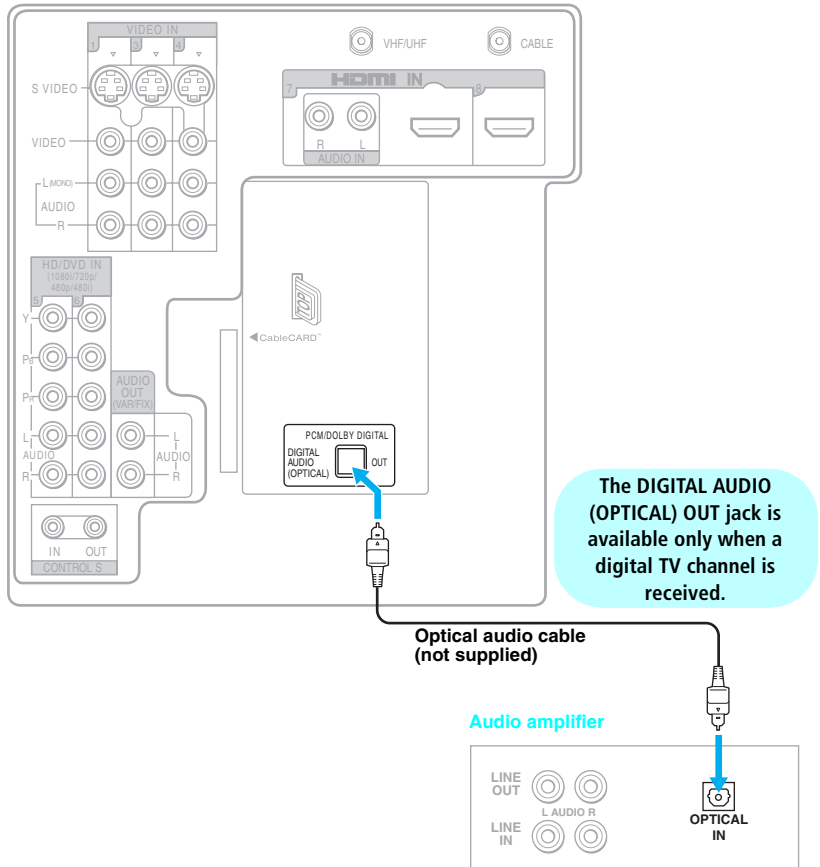

## Using the CONTROL S Feature

CONTROL S allows you to control your LCD projection TV system and other Sony equipment with one remote control. In addition to allowing you to control multiple devices with one remote control, the CONTROL S feature allows you to always point your remote control at your LCD projection TV, instead of having to point it at the other equipment, which might be hidden or out of direct line of sight.

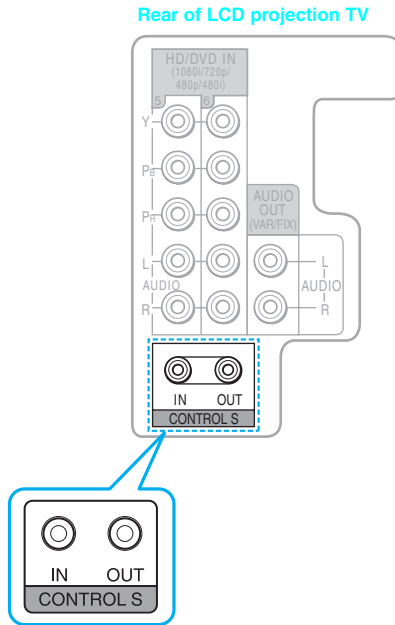

## Using CableCARD

CableCARD provides cable subscribers with access to digitally encrypted cable channels — without the need for a set-top box — that will enable you to receive not only standard definition but also high definition television. The CableCARD, which is provided by your cable TV company, is inserted into the TV's rear panel CableCARD slot. After the service is activated with your cable TV company, the card replaces the need for a separate set-top box.

### About Using CableCARD

If you are planning to use a separate cable box for digital cable TV services, you may be able to receive programming using this TV with the CableCARD instead — except in the following circumstances:

- ❑ Your cable TV company does not provide CableCARD service in your viewing area.
- ❑ You want to access your cable TV company's interactive or advanced features (such as video-on-demand or, in some cases, pay-per-view). At this time, these services require a bidirectional link, which are only available through the use of a separate set-top box. CableCARD is currently a unidirectional device only, and cannot provide these advanced services.

Check with your cable TV company for CableCARD service details, limitations, pricing, and availability, all of which are determined by your cable TV company — not Sony.

### Activating CableCARD Service

Before you can use CableCARD service, you need to insert the CableCARD (supplied by your cable TV company) and activate the service, as described below:

- 1 Turn off the TV.
- 2 Insert the CableCARD into the TV's CableCARD slot.

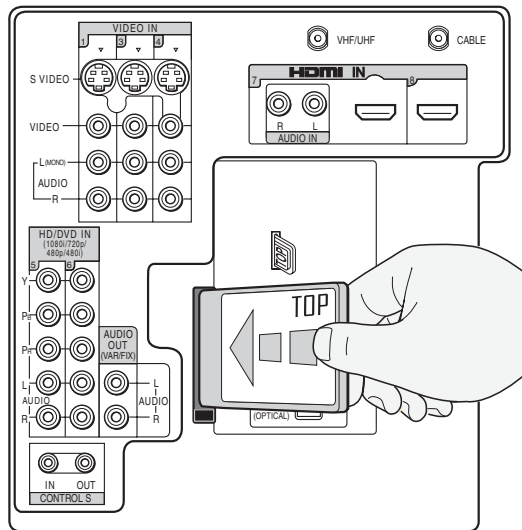

**CAUTION:** Inserting the CableCARD incorrectly may result in permanent damage to the card and the TV.



 You can also access information about your CableCARD in the Applications Menu (see page 112).

- 3** Gently push the card into the slot until it locks into place.
- 4** Turn on the TV. After 1-2 minutes, the CableCARD setup screen is automatically displayed. This screen includes information your cable TV company will request before they can activate your service.
- 5** Follow the displayed instructions: Phone your cable TV company. A representative will guide you through the activation process.
- 6** After your CableCARD is activated, your cable TV company will download the service information, including the channel list, to the CableCARD. After the CableCARD has acquired channels from your cable TV company, the TV tunes to the lowest available channel.

## Removing the CableCARD

In the event you want to cancel your service, contact your cable TV company.

 Once the CableCARD is removed, your TV will no longer decrypt digital cable TV programming services that require CableCARD.

- 1** Turn off the TV.
- 2** Push the eject button on the TV's CableCARD slot to release the card.

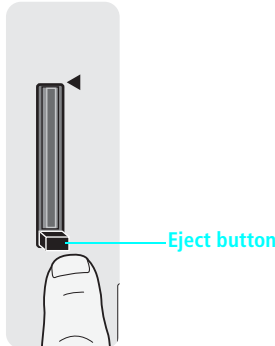

- 3** Pull the CableCARD straight out of the slot to remove it.

To install a different CableCARD, follow the instructions in "Activating CableCARD Service" on page 52.

## Setting Up the LCD Projection TV Channel List

After you finish connecting the TV, you need to run the Initial Setup feature, which automatically creates a list of available analog and digital channels. The Initial Setup screen appears when you turn on your TV for the first time after hooking it up. If you do not want to set up the channels at this time, you can do it later by selecting the Auto Program option in the Channel menu (see page 102).

 The Initial Setup feature does not apply for installations that use a cable box for all channel selection.

### Using Initial Setup

 If you are using a CableCARD, Auto Program is disabled for the CABLE input.

#### To run Initial Setup the first time you turn on your TV

- 1** Press **POWER** to turn on the TV.  
The Initial Setup screen appears.
- 2** Press **▲** or **▼** to select the on-screen display language. Then press **⏏**.  
The message “Start auto program now?” appears.
- 3** Press **▲** or **▼** to select “Yes”, then press **⏏**.

Initial Setup automatically creates a list of receivable channels. When finished, the lowest numbered channel is displayed.

#### To run Auto Program again at a later time

- Use the Auto Program feature as described on page 102.

#### To add individual digital channels

- Use the Digital Channel feature as described on page 102.

 Auto Program may take up to 50 minutes to complete. A progress bar is displayed while the channel list is being created.

# Using the Remote Control

## Overview

The table on the next page describes the buttons on the remote control.

## Inserting Batteries into the Remote Control

Insert two size AA (R6) batteries (supplied) by matching the **+** and **-** on the batteries to the diagram inside the battery compartment.

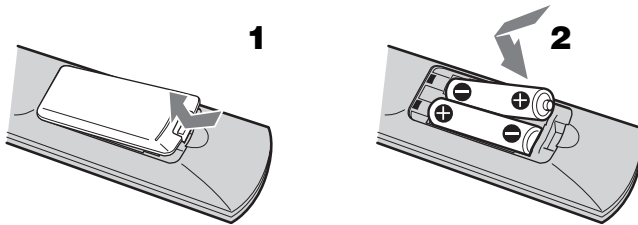

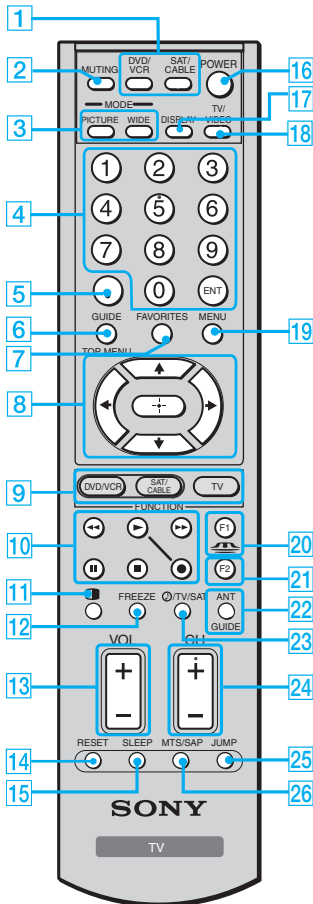

- ✎ To avoid possible damage from battery leakage, remove the batteries if you anticipate the remote control will not be used for an extended period.
- ✎ Handle the remote control with care. Avoid dropping it, getting it wet, or placing it in direct sunlight, near a heater, or in high humidity.
- ✎ Your remote control can be programmed to operate most video equipment. (See “Programming the Remote Control” on page 58.)

## Button Descriptions



Button	Description
<b>1</b> DVD/VCR, SAT/CABLE, POWER Buttons	Press to turn on and off the equipment you have programmed into the remote control. For details, see “Programming the Remote Control” on page 58. <b>DVD/VCR:</b> Press to turn on and off the video equipment. <b>SAT/CABLE:</b> Press to turn on and off the satellite receiver or cable box.
<b>2</b> MUTING	Press to mute the sound. Press again or press <b>VOL +</b> to unmute.
<b>3</b> PICTURE MODE	Press repeatedly to cycle through the available video picture modes: <b>Vivid, Standard, Pro</b> . The video picture modes can be also accessed in the Video menu. For details, see “Selecting Video Options” on page 94. <b>WIDE MODE</b> Press repeatedly to step through the Wide Screen Mode setting: <b>Wide Zoom, Normal, Full</b> and <b>Zoom</b> . The Wide Screen Mode setting can be also accessed in the Screen menu. For details, see “Using Wide Screen Mode” on page 66.
<b>4</b> 0-9, ENT	Press <b>0-9</b> to select a channel: the channel changes after 2 seconds. Press <b>ENT</b> to change channels immediately.
<b>5</b>	Use  with <b>0-9</b> and <b>ENT</b> buttons to select digital channels (for example, 2.1). For details on selecting digital channels, see page 64.
<b>6</b> GUIDE TOP MENU	Press to display the TV’s program guide. When <b>FUNCTION</b> is switched on <b>SAT/CABLE</b> , press to display the program guide of your satellite program provider.
<b>7</b> FAVORITES	Press to display the Favorite Channels list. For details, see page 71.
<b>8</b>	Press  to move the on-screen cursor. To select an item, press .
<b>9</b> FUNCTION Buttons	Press to have the remote control operate the equipment you want. For details, see “Programming the Remote Control” on page 58.
<b>10</b> DVD/VCR Operating Buttons	When <b>FUNCTION</b> is switched on <b>DVD/VCR</b> , these buttons operate the video equipment you have programmed into the remote control. For details, see “Using Other Equipment with Your LCD Projection TV Remote Control” on page 60. : Pause : Stop : Fast-Reverse : Play : Fast-Forward : Record by pressing  and
<b>11</b> (Twin View)	Press to turn on/off Twin View. For details, see “Using Twin View” on page 68.
<b>12</b> FREEZE	Press to freeze the current picture in a separate window. Press again to restore the picture. For details, see “Using the Freeze Function” on page 73.
<b>13</b> VOL +/-	Press to adjust the volume.
<b>14</b> RESET	Press when in a menu, to reset the setting to the factory defaults. Also used to clear Label Channels or Favorite Channels.

Button	Description
15 SLEEP	Press repeatedly until the TV displays the time in minutes (15, 30, 45, 60 or 90) that you want the LCD projection TV to remain on before shutting off. To cancel Sleep Timer, press <b>SLEEP</b> repeatedly until Sleep Off appears.
16 POWER (GREEN)	Press to turn on/off the LCD projection TV.
17 DISPLAY	Press once to display channel number, label, current time and other information. Press again to turn Display off. See page 111 for details on setting the time.
18 TV/VIDEO	Press to cycle through the video equipment connected to your LCD projection TV's video inputs.
19 MENU	Press to display the menu. Press again to exit from the menu. For details, see "Using the Menus" on page 93.
20 F1	Press to select the function of connected components. For details, see "Using Other Equipment with Your LCD Projection TV Remote Control" on page 60.
	When <b>FUNCTION</b> is switched on <b>TV</b> , press to display the Memory Stick menu. For details, see "Using the Memory Stick Viewer" on page 75.
21 F2	Press to select the function of connected components. For details, see "Using Other Equipment with Your LCD Projection TV Remote Control" on page 60.
22 ANT GUIDE	Press to change between the VHF/UHF input and the CABLE input. When <b>FUNCTION</b> is switched on <b>SAT/CABLE</b> , press to display the program guide of your satellite receiver.
23  /TV/SAT	<b>TV/SAT</b> : Press to select the TV or satellite receiver.  : Press repeatedly to step through the available audio effect modes: <b>TruSurround</b> , <b>Simulated</b> , <b>Off</b> . For details, see "Selecting Audio Options" on page 98.
24 CH +/-	Press to scan through channels. To scan quickly through channels, press and hold down either CH button.
25 JUMP	Press to jump back and forth between two channels. The LCD projection TV alternates between the current channel and the last channel that was selected.
26 MTS/SAP	Press repeatedly to cycle through the Multi-channel TV Sound (MTS) options: <b>Stereo</b> , <b>Auto SAP</b> (Second Audio Program), and <b>Mono</b> . The MTS setting can be also accessed in the Audio menu. For more details, see "Selecting Audio Options" on page 98.

## Programming the Remote Control

The remote control is preset to operate Sony brand video equipment.

Sony Equipment	Programmable Code Number
DVD/VCR	601 (Sony Dream System)
SAT/CABLE	801 (Sony Satellite Receiver)

If you have video equipment other than Sony brand that you want to control with the LCD projection TV's remote control, use the following procedure to program the remote control.

 The equipment must have infrared (IR) remote capability in order to be used with the remote control.

From the "Manufacturer's Codes" listed on page 59, select the three-digit code number for the manufacture's code of your equipment. If more than one code number is listed, try entering them one by one until you come to the correct code for your equipment. Use the code number to complete the following procedure.

- 1** Press the DVD/VCR (FUNCTION) and RESET buttons simultaneously, or press the SAT/CABLE (FUNCTION) and RESET buttons simultaneously. DVD/VCR and SAT/CABLE buttons flash.
- 2** Press the function button you want to program.  
**To program a cable box or a satellite receiver**  
Press SAT/CABLE (FUNCTION).  
**To program video equipment**  
Press DVD/VCR (FUNCTION).
- 3** Enter the three-digit manufacturer's code number using the 0-9 buttons.
- 4** Press ENT (enter) button.

 If no code number is input within 10 seconds, or an invalid or incorrect code number is input, the remote control automatically goes back to the previous setting.

- 5** To check if the code number works, aim the TV's remote control at the equipment and press DVD/VCR and/or SAT/CABLE (POWER) that corresponds with that equipment. If it responds, the programming is completed. If not, try using the other codes listed for that manufacturer.

 In some cases, you may not be able to operate your equipment with the supplied remote control. In such cases, use the equipment's own remote control unit.

## Manufacturer's Codes

### DVD Players

Manufacturer	Code
Sony	751
General Electric	755
Hitachi	758
JVC	756
Magnvox	757
Mitsubishi	761
Panasonic	753
Philips	757
Pioneer	752
RCA/PROSCAN	755
Samsung	758
Toshiba	754
Zenith	760

### DVD Changers

Manufacturer	Code
Sony	765
Panasonic	766

### DVD/VCR Combo Units

Manufacturer	Code
Sony	767
Broksonic	776
JVC	775
Panasonic	777
Samsung	774
Toshiba	773
Zenith	768

### HDD/DVD Combo Units

Manufacturer	Code
Sony	770, 771, 772

### 5.1ch DVD AV System

Manufacturer	Code
Sony (DAV)	601, 602, 603, 604

### AV Receivers

Manufacturer	Code
Sony	764

### VCRs

Manufacturer	Code
Sony	301, 302, 303
Admiral (M. Ward)	327
Aiwa*	338, 344

Manufacturer	Code
Audio Dynamic	314, 337
Broksonic	319, 317
Canon	309, 308
Citizen	332
Craig	302, 332
Curtis Mathes	304, 338, 309
Daewoo	341, 312, 309
DBX	314, 336, 337
Dimensia	304
Emerson	319, 320, 316, 317, 318, 341
Fisher	330, 335
Funai	338
General Electric	329, 304, 309
Go Video	322, 339, 340
Goldstar	332
Hitachi	306, 304, 305, 338
Instant Replay	309, 308
JC Penney	309, 305, 304, 330, 314, 336, 337
JVC	314, 336, 337, 345, 346, 347
Kenwood	314, 336, 332, 337
LG	332
LXI (SEARS)	332, 305, 330, 335, 338
Magnavox	308, 309, 310
Marantz	314, 336, 337
Marta	332
Memorex	309, 335
Minolta	305, 304
Mitsubishi/MGA	323, 324, 325, 326
Multitech	325, 338, 321
NEC	314, 336, 337
Olympic	309, 308
Optimus	327
Orion	317
Panasonic	308, 309, 306, 307
Pentax	305, 304
Philco	308, 309
Philips	308, 309, 310
Pioneer	308
Quasar	308, 309, 306
RCA/PROSCAN	304, 305, 308, 309, 311, 312, 313, 310, 329
Realistic	309, 330, 328, 335, 324, 338
Sansui	314

Manufacturer	Code
Samsung	322, 313, 321
Sanyo	330, 335
Scott	312, 313, 321, 335, 323, 324, 325, 326
Sharp	327, 328
Signature 2000 (M. Ward)	338, 327
SV2000	338
Sylvania	308, 309, 338, 310
Symphonic	338
Tashiro	332
Tatung	314, 336, 337
Teac	314, 336, 338, 337
Technics	309, 308
Toshiba	312, 311
Wards	327, 328, 335, 331, 332
Yamaha	314, 330, 336, 337
Zenith	331

### Cable Boxes

Manufacturer	Code
Sony	230
Hamlin/Regal	222, 223, 224, 225, 226
Jerrold/G. I./ Motorola	201, 202, 203, 204, 205, 206, 207, 208, 218, 222
Oak	227, 228, 229
Panasonic	219, 220, 221
Pioneer	214, 215
Scientific Atlanta	209, 210, 211
Tocom	216, 217
Zenith	212, 213

### Satellite Receivers

Manufacturer	Code
Sony	801
Dish Network	810
Echostar	810
General Electric	802
Hitachi	805
Hughes	804
Mitsubishi	809
Panasonic	803
RCA/PROSCAN	802, 808
Toshiba	806, 807

\* If an Aiwa VCR does not work even though you enter the code for Aiwa, enter the code for Sony instead.

## Using Other Equipment with Your LCD Projection TV Remote Control

To operate other connected equipment with your LCD projection TV remote control, first turn to page 59 and program the necessary code. For operating video equipment, press **TV/VIDEO** repeatedly till you see the video input on the screen for your connected equipment. Remote control operation tips are provided below.

### Operating a Cable Box

To Do This ...	Press
Activate the remote control to operate the cable box	<b>SAT/CABLE (FUNCTION)</b>
Turn on/off	<b>SAT/CABLE (POWER)</b>
Select a channel	<b>0-9, ENT</b>
Change channels	<b>CH +/-</b>
Back to previous channel	<b>JUMP</b>

### Operating a Satellite Receiver

To Do This ...	Press
Activate the remote control to operate the satellite receiver	<b>SAT/CABLE (FUNCTION)</b>
Turn on/off	<b>SAT/CABLE (POWER)</b>
Select a channel	<b>0-9, ENT</b>
Change channels	<b>CH +/-</b>
Back to previous channel	<b>JUMP</b>
Display channel number	<b>DISPLAY</b>
Display SAT Guide	<b>GUIDE</b>
Display SAT Menu	<b>MENU</b>
Move highlight (cursor)	<b>↑ ↓ ← →</b>
Select item	<b>+/-</b>



## Operating a VCR

To Do This ...	Press
Activate the remote control to operate the VCR	DVD/VCR (FUNCTION)
Turn on/off	DVD/VCR (POWER)
Change channels	CH +/-
Record	● and ▶ simultaneously
Play	▶
Stop	■
Fast forward	▶▶
Rewind the tape	◀◀
Pause	
Search the picture forward or backward	▶▶ or ◀◀ during playback (release to resume normal playback)

## Operating a DVD Player or DVD Changer

To Do This ...	Press
Activate the remote control to operate the DVD	DVD/VCR (FUNCTION)
Turn on/off	DVD/VCR (POWER)
If you have a DVD changer, to skip disk	F1
Play	▶
Stop	■
Pause	(press again to resume normal playback)
Step through different tracks of the disc	▶▶ to step forward or ◀◀ to step backward
Step through different chapters of the disc	CH + to step forward or CH - to step backward
Select a track directly	0-9, ENT
Display the menu (setup)	MENU
Display the top menu	TOP MENU
Operate the DVD menu	↑ ↓ ← → (+)

## Operating a 5.1ch DVD AV System (SONY DAV)

To Do This ...	Press
Activate the remote control to operate the DAV	DVD/VCR (FUNCTION)
Turn on/off	DVD/VCR (POWER)
Select other equipment connected to the DAV	F1
Skip a disk	F2
Display the DVD menu	TOP MENU
Display the menu (Setup)	MENU

(Continued)

## Using the Remote Control

Move highlight (Cursor)	↑ ↓ ← →
Select item	⏏
Change the volume	VOL +/-, MUTING

## Operating a DVD/VCR or HDD/DVD Combo Unit

To Do This ...	Press	
Activate the remote control to operate the DVD/VCR or HDD/DVD	DVD/VCR (FUNCTION)	
Turn on/off	DVD/VCR (POWER)	
If you have a DVD/VCR combo component,		
Select the DVD	F1	
Select the VCR	F2	
If you have a HDD/DVD combo component,		
Select the DVD	F1	
Select the HDD	F2	
Record	● and ▶ simultaneously	(VCR)
Play	▶	(VCR)
Stop	■	(VCR)
Fast forward	▶▶	(VCR)
Rewind the tape	◀◀	(VCR)
Pause		(VCR)
Search the picture forward or backward	▶▶ or ◀◀ during playback (release to resume normal playback)	(VCR)
Display the DVD menu	TOP MENU	(DVD)
Play	▶	(DVD)
Stop	■	(DVD)
Pause		(DVD)
Step through different tracks of the disc	▶▶ to step forward or ◀◀ to step backward	(DVD)
Step through different chapters of a video disc	CH + to step forward or CH - to step backward	(DVD)

## Operating an AV Receiver

To Do This ...	Press
Turn on/off	DVD/VCR (POWER)
Change the volume	VOL +/-, MUTING

# Using the Features

## Overview

This chapter describes how to use the features of your TV.

Topic	Page
Watching TV	63
Using the Program Guide	64
Using Wide Screen Mode	66
Using Twin View	68
Using Favorite Channels	71
Using the Freeze Function	73

## Watching TV

 For a complete list of all the functions of the remote control, see pages 55-62.

To Do This ...	Do This ...
Activate the remote control to operate the TV	Press <b>TV FUNCTION</b> .
Turn on/off the TV	Press <b>TV POWER</b> .
Tune directly to a channel	To tune to analog channels, press <b>0-9</b> and then <b>ENT</b> . For digital subchannels, press <b>0-9</b> , <b>⊙</b> , press <b>0-9</b> again, and then <b>ENT</b> .  For example, to select subchannel 21.13, press <b>2+1+⊙+1+3</b> , and then press <b>ENT</b> . You can also select channels using the program guide. See page 65 for details.
Adjust the volume	Press <b>VOL +/-</b> .
Mute the sound	Press <b>MUTING</b> (press again or <b>VOL +</b> to unmute).
Alternate back and forth between two channels	Press <b>JUMP</b> . The LCD projection TV alternates between the current channel and the last channel that was selected.
Display the current channel number (and other information)	Press <b>DISPLAY</b> once to display the channel number, current time, and channel label (if set). Press <b>DISPLAY</b> again to turn Display off.
Switch the TV's input to the VCR, DVD player, or other connected equipment	Press <b>TV/VIDEO</b> repeatedly to cycle through the video equipment connected to the TV's video inputs.
Change video and audio options, customize the TV's setup, set parental controls, and more	Press <b>MENU</b> to display the Menu. For details, see "Using the Menus" on page 93.
Switch the TV's input between sources connected to the TV's VHF/UHF and CABLE inputs	Press <b>ANT</b> to alternate between sources connected to the TV's VHF/UHF and CABLE inputs.

## Using the Program Guide

### Displaying the Program Guide

This LCD projection TV is equipped to show program information if it is available from the station. The program guide lets you review program information and select both analog and digital channels.

#### To display the program guide:

- 1 Tune your LCD projection TV to a channel by using the 0-9,  $\odot$ , and ENT buttons.
- 2 Press **GUIDE (TOP MENU)** on the LCD projection TV's remote control. The program guide will appear with the currently selected program showing in the background.

Channel number, call letters, etc.

Program title and description, program duration, time remaining, rating information, closed-caption availability, etc.

Selectable channel list.



 Program information in the guide is provided by the broadcasters. As a result, it may sometimes include only the channel number, without a program title or description.

## Using the Guide Menu

The Program Guide menu allows you to select channels from a dropdown list. The Guide provides information about the current program being shown on each channel.

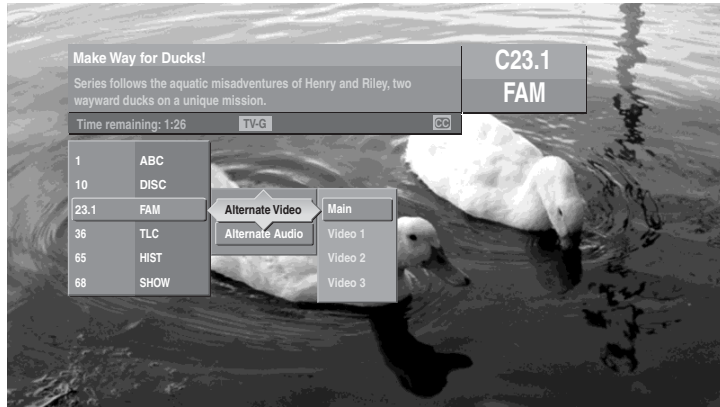

 Subchannels are additional channels of programming broadcast simultaneously. For example, channel 4 might include three subchannels (4.1, 4.2, 4.3) that are showing programs at the same time.

## Using the Program Options Menu

The Program Options menu allows you to customize the program settings on the currently tuned channel.

Option	Description
<b>Alternate Video</b> (when available)	Each program has a main video stream (the video that you see when the channel is first tuned), and may have alternate video streams. This option allows you to switch among these alternate video streams.
<b>Alternate Audio</b> (when available)	Each program has a main audio stream (the audio you hear when the channel is first tuned). This option allows you to switch among these, and may have alternate audio streams (e.g., for different languages).

## Using Wide Screen Mode

 You can also access the screen mode settings in the Screen menu. For details, see page 100.

Wide screen mode lets you watch 4:3 normal broadcasts in several wide screen modes (16:9 aspect ratio).

- Press **WIDE** repeatedly to toggle through the following screen mode settings.

### Changing the Wide Screen Mode for 4:3 Source (Standard definition source)

original source

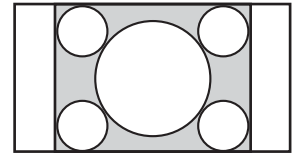

#### Example

#### Description



Wide Zoom

**Wide Zoom** enlarges the center portion of the picture. The left and right edges of the picture are stretched to fill the 16:9 screen.

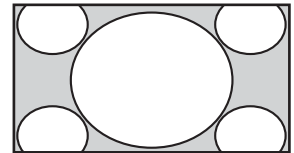

Normal

**Normal** displays the 4:3 picture in its original size. Side bars are shown to fill the 16:9 screen.

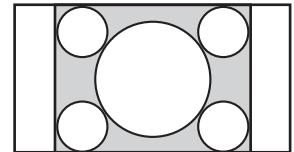

Full

**Full** stretches the 4:3 picture horizontally, to fill the 16:9 screen.

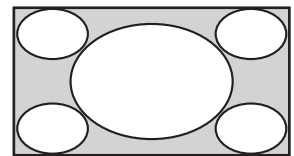

Zoom

**Zoom** enlarges the 4:3 picture to fill the 16:9 screen. **Zoom** is useful for watching Letterbox movies.

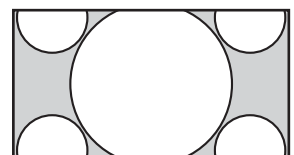

 When you change channels or inputs, the Wide Mode settings revert to the 4:3 Default setting in the Screen Menu. To retain the current Wide Mode setting as channels and inputs are changed, set 4:3 Default to Off. For details, see page 101.

## Changing the Wide Screen Mode for 16:9 Source (High definition source)

original source



(Upconverted 4:3)



(Native 16:9)

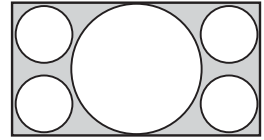
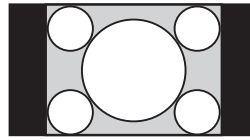

### Example

### Description



**Wide Zoom** enlarges the center portion of the picture. The left and right edges of the picture are stretched to fill the 16:9 screen.

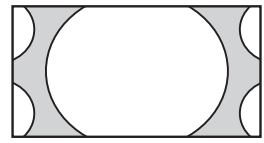
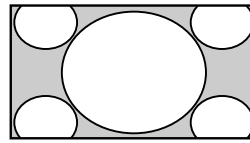

Wide Zoom



**Normal**

(This mode is not available.)



**Full** displays the picture at its original size.

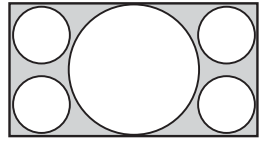
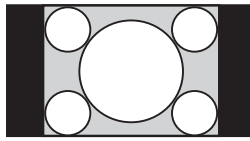

Full



**Zoom** enlarges the picture proportionately, both vertically and horizontally.

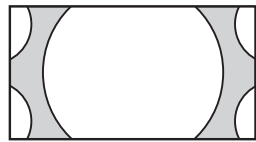
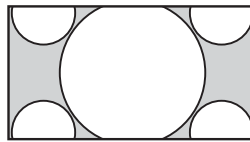

Zoom

- 🔍 When the TV receives a 720p or 1080i signal, Normal cannot be selected.
- 🔍 When TV receives a 720p or 1080i signal that is 4:3 aspect ratio picture (upconverted to 16:9) with a black bar at each side, Full returns the picture to its original size.

## Using Twin View

Twin View lets you see two pictures from two sources — from an antenna, VCR, DVD, etc. — on the screen at the same time. You hear the sound from only one of the sources at a time, but you can choose which source's sound is selected. You can also change the relative size of each of the pictures.

### Displaying Twin Pictures



#### To display Twin View

- 1 Make sure your LCD projection TV is tuned to a working channel.
- 2 Press .

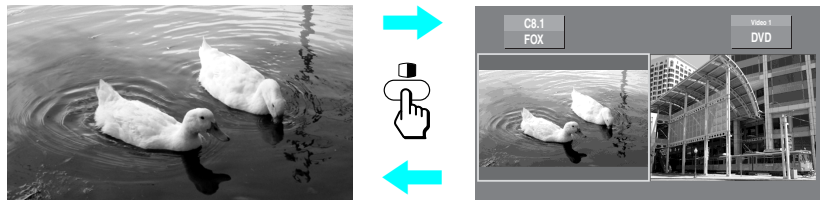

A second picture appears. The active picture is highlighted.



#### To cancel Twin View and watch the active picture

- Press  again (or press ).

### Activating the Picture

You can use  or  buttons to activate the left and right pictures while using Twin View.

#### To activate the right picture

- Press .



#### To activate the left picture

- Press .





## Functions Available in the Active (Highlighted) Window

To Do This ...	Do This ...
Tune to a channel	To tune to analog channels, press <b>0-9</b> and then <b>ENT</b> . For digital subchannels, press <b>0-9</b> , <b>⊙</b> , press <b>0-9</b> again, and then <b>ENT</b> .  For example, to select subchannel 21.13, press <b>2+1+⊙+1+3</b> , and then press <b>ENT</b> .
Adjust the volume	Press <b>VOL +/-</b>
Mute the sound	Press <b>MUTING</b> (press again or press <b>VOL +</b> to unmute)
Switch the TV's input between sources connected to the TV's VHF/UHF and CABLE inputs	Press <b>ANT</b>
Switch the TV's input between sources connected to the TV's A/V inputs	Press <b>TV/VIDEO</b>
Change the picture size	Press <b>↕</b> or <b>↔</b> . (For details, see "Changing the Picture Size" on page 70.)

## Factors Affecting Twin View

- ❑ If you use a cable box to view all channels, the same channel appears in both windows because the cable box unscrambles and sends only one channel at a time. (To view the picture in dual picture features such as Twin View, Freeze, etc. see "Cable Box and Cable" on page 31.)
- ❑ If you use a cable box and other video equipment, you can view the cable box output in one window and view a different source (such as a VCR or DVD player) in the second window by using the **TV/VIDEO** button.
- ❑ Digital TV channels, as well as any sources connected to the HD/DVD IN 5-6, and HDMI IN 7-8 inputs display in the left window, but not the right.
- ❑ If you are viewing a 4:3 source and a 16:9 enhanced source (such as a DVD) side by side, the 4:3 source appears larger.
- ❑ Twin View does not display channels that are blocked by parental settings (see page 104).

## Changing the Picture Size

The zoom feature lets you change the size of the left and right pictures.

**To enlarge the left picture (reduce the right)**

- 1 Press ◀ to activate the left picture (if not already activated).
- 2 Press ▲ to enlarge the picture and ▼ to reduce the picture.

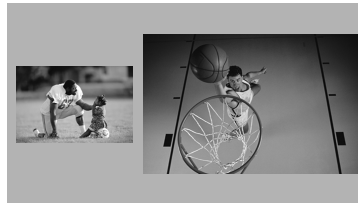

**To enlarge the right picture (reduce the left)**

- 1 Press ▶ to activate the right picture (if not already activated).
- 2 Press ▲ to enlarge the picture and ▼ to reduce the picture.

 When you adjust the picture sizes in Twin View, the LCD projection TV memorizes the change. The next time you use the Twin View function, the memorized sizes appear.

## Using Favorite Channels

The Favorite Channels feature lets you select programs from a list of up to 16 favorite channels that you specify. You can create a list using the Favorite Channels option in the Channel Menu, or by using the Add to Favorites feature in the Favorite Channels guide.

### Using the Channel Menu

 For details on using the Channel Menu, see page 102.

- 1** Press **MENU** to display the Menu.
- 2** Press **▲** or **▼** to highlight the Channel icon and press **(+)**.
- 3** Press **(+)** to select **Favorite Channels**.
- 4** Use the **0-9** and **ENT** buttons to enter the channel number that you want to assign to the Favorite Channel number. A preview of the highlighted channel appears in the upper right of the screen.

 Digital channels do not display in the preview window.

Press **(+)** to select that channel as a **Favorite Channel**.

 To enter digital channel numbers in step 4, use the 0-9, **○**, 0-9 and **ENT** buttons.

- 5** To add more channels to your favorites list, repeat step 4.  
To clear a Favorite Channel, press **▲** or **▼** to highlight the channel you want to clear. Press **RESET**.
- 6** Press **MENU** to exit the Menu.

## Using the Favorite Channels Guide

- 1 Press **FAVORITES**.

The Favorite Channels list appears.

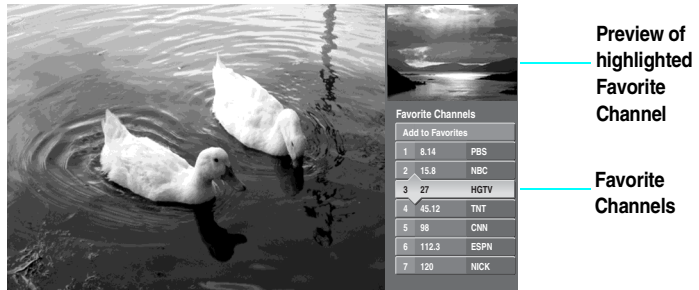

- 2 Press **▲** or **▼** to highlight the channel you want to watch. A preview of the highlighted Favorite Channel appears.

 Digital channels do not display in the preview window.

To add the current channel to the list of Favorite Channels, highlight **Add to Favorites** and press **(+)**.

- 3 Press **(+)** to select the channel you want to watch.

To change your Favorite Channels list, highlight **Edit Favorites** and press **(+)**.

## Using the Freeze Function

The **FREEZE** button allows you to temporarily capture a program's picture. You can use this feature to write down information such as phone numbers, recipes, etc.

 The Freeze feature is not available if you are in Favorite Channels (see page 71) or Twin View (see page 68) mode.

### To use the Freeze function

- 1** When the program information you want to capture is displayed on the screen, press **FREEZE**.
- 2** The LCD projection TV switches to Twin View mode and displays the "frozen" picture on the right, while the current program continues on the left.



- 3** To cancel and return to normal viewing, press **FREEZE** again (or just turn to another channel).



# Using the Memory Stick Viewer

## About Memory Stick

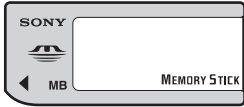

Memory Stick (sold separately) is a new, compact, portable, and versatile Integrated Circuit recording medium with a data capacity that exceeds that of a floppy disk. Memory Stick is specially designed for sharing digital data among Memory Stick compatible products such as digital cameras and digital video cameras. Because it is removable, Memory Stick can also be used for external data storage.

The Memory Stick Viewer on your LCD projection TV allows you to view files that are stored on Memory Stick media. You can view:

- ❑ Digital photos (JPEG files)
- ❑ Movies (MPEG1 files)

You can also play slide show background music using MP3 files stored on your Memory Stick.

For more information about handling Memory Stick media, see “Notes on Using Memory Stick Media” on page 90.

---

## Features

With the Memory Stick Viewer, you can:

- ❑ View photo (JPEG) and movie (MPEG1) files in a thumbnail index or Slide Show
- ❑ Set customized Slide Show options, including transitions and background audio
- ❑ Pan, zoom, and rotate photos
- ❑ Mark photos and set quantities of prints to be output when the Memory Stick is inserted into your photo printer (not supplied)
- ❑ Lock (protect) or delete files on the Memory Stick

---

## Memory Stick Compatibility

This television is compatible with the following Sony brand Memory Stick media types:

- Memory Stick Media
- Memory Stick Duo and PRO Duo Media (can be used without the Memory Stick adaptor)

 The Memory Stick slot on your TV has been designed to accommodate standard and compact versions of Memory Stick. It is not necessary to use an adaptor for Memory Stick Duo and Memory Stick PRO Duo. If you use an adaptor, it may damage the adaptor and Memory Stick slot.

- Memory Stick Media with Memory Select Function
- Memory Stick PRO Media

### About Memory Stick PRO Media

Memory Stick PRO media features vary by and are dependent upon the design of host hardware devices. Memory Stick PRO in this LCD projection TV has been tested to support up to 1 GB media capacity and does not support high-speed transfer, MagicGate copyright protection technology, or access control security features.

---

## Memory Stick Functionality

Sony cannot guarantee or assure the Memory Stick functionality on this television in the following cases:

- You are using non-Sony brand Memory Stick media.
- You are using video or audio clips that have been processed on a computer.
- You are using files that were obtained from the Internet or from a printed film processing center.
- The Memory Stick has been formatted on a personal computer.

Sony recommends that you back up all data stored on Memory Stick media to avoid potential data loss. In the above two cases, in order to avoid potential data corruption that may occur, be sure to back up data prior to use with the TV's Memory Stick Viewer. Sony cannot accept responsibility in the event that data recorded to Memory Stick media is lost or damaged. For certain non-Sony brand Memory Stick media, you can view images, but you cannot rotate, delete or protect/unprotect images on the television. An error message will occur if you attempt any of these operations. This is a result of the unique file directory structure on these particular flash memory media and is not a malfunction of the television.



---

## **File Compatibility**

The Memory Stick Viewer is compatible with JPEG images taken with Sony digital still cameras and MPEG1\* movies taken with Sony digital cameras and camcorders. To be viewable in the Memory Stick Viewer, files must have the following file name extensions:

<i>File Type</i>	<i>Supported File Name Extensions</i>
JPEG	.jpg .jpeg
MPEG1	.mpg .mpeg

---

## **Trademark Information**

Memory Stick, Memory Stick Duo, Memory Stick PRO, Memory Stick PRO Duo, and MagicGate are trademarks of Sony Corporation.

\* Some variations of MPEG1 movies may not play back correctly.

## Inserting and Removing a Memory Stick

If you are using a Memory Stick Duo and PRO Duo, see “Inserting the Memory Stick Duo” on page 79.

### Inserting a Memory Stick

Locate the Memory Stick slot and insert the Memory Stick into the Memory Stick slot as illustrated below. When inserted properly, it should slide in with little resistance and click into place.

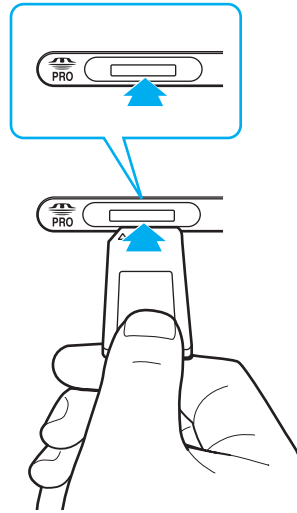

- ✎ Be sure to insert the Memory Stick in the correct direction. Forcing the Memory Stick in the wrong way may damage it.
- ✎ Insert only Memory Stick media into the Memory Stick slot. Attempting to insert other objects into the Memory Stick slot may damage the LCD projection TV.

To remove the Memory Stick, see “Removing a Memory Stick” on page 80.

## Inserting the Memory Stick Duo

Memory Stick Duo is a new, compact version of the standard-sized Memory Stick recording medium.

- CAUTION: The Memory Stick slot on your TV has been designed to accommodate standard and compact versions of Memory Stick. It is not necessary to use an adaptor for Memory Stick Duo and Memory Stick PRO Duo. If you use an adaptor, it may damage the adaptor and Memory Stick slot.
- CAUTION: Inserting the Memory Stick Duo incorrectly may result in permanent damage to the Memory Stick Duo and the LCD projection TV.

Insert the Memory Stick Duo as shown below.

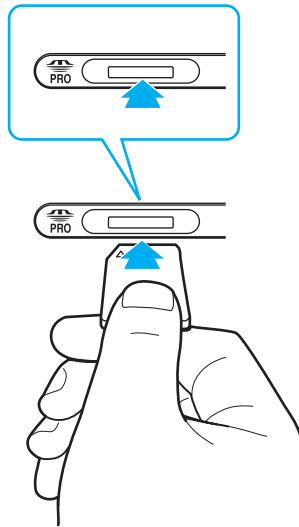

To remove the Memory Stick Duo, see “Removing a Memory Stick” on page 80.

## Removing a Memory Stick

**1** Check that the Memory Stick indicator is off. (When the light is on, this indicates that the LCD projection TV is reading data from the Memory Stick.)

 Removing the Memory Stick while a file is being accessed (when the Memory Stick indicator on the LCD projection TV's front panel is lit) may damage the Memory Stick or its contents.

**2** Push the Memory Stick gently into the Memory Stick slot, and then release it. The Memory Stick media is ejected.

 When removing the Memory Stick, do not attempt to pull it from its slot without first pushing it in to release it.

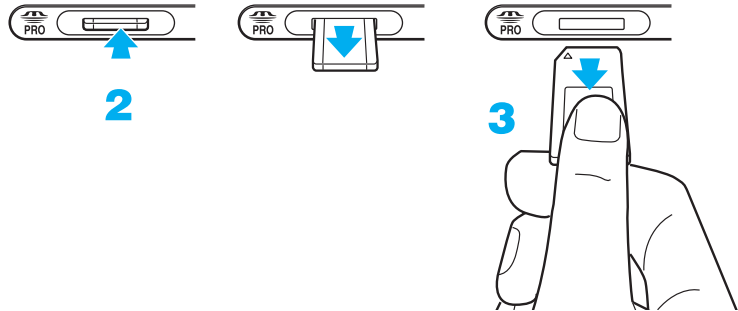

**3** Pull the Memory Stick completely out of the slot.

 To protect small children from injury by Memory Stick media, remove all Memory Stick media from the LCD projection TV's Memory Stick slot and store in a safe location when not in use.



## Using the Memory Stick Index

Turn on the LCD projection TV and insert a Memory Stick that contains the photo or movie files you want to view. To insert a Memory Stick, see “Inserting a Memory Stick” on page 78.

 If the Memory Stick Index does not appear, press /F1 button on the remote control.

The Memory Stick Index appears, which displays thumbnail images of the files stored on the Memory Stick.



### About the Lock and Movie Icons on the Thumbnail Images

-  Indicates the thumbnail is a movie (MPEG1) file instead of a photo (JPEG) file.

---

-  Indicates the thumbnail is locked. Locked files cannot be changed or deleted. For details, see “Protect” on page 84 and 87.

---

-  Indicates that the photo is marked to be printed.

---

-  Indicates that the photo has an associated voice memo.

## Using the Memory Stick Index

The following describes how to use the Memory Stick Index.

To Do This ...	Do This ...
Move the highlight to a photo, voice memo (🎙️), or movie (🎬) thumbnail	Press <b>↑ ↓ ← →</b> .
Display the highlighted photo, voice memo, or movie file full screen	Press <b>⏏</b> . For details, see “Viewing Photos” on page 83 and “Playing Movies” on page 86.
Display the next page of thumbnails	<b>1</b> Press <b>↓</b> to select <b>▼</b> . <b>2</b> Press <b>↓</b> to display the next page of thumbnails.
Display the previous or next page of thumbnails	<b>1</b> Press <b>↓</b> to select <b>▼</b> . <b>2</b> Press <b>←</b> to select <b>◀</b> . <b>3</b> To go to the previous page, press <b>↑</b> . To go to the next page, press <b>↓</b> .
Use the Memory Stick Menu bar to access additional options	<b>1</b> Press <b>↓</b> to select <b>▼</b> . <b>2</b> Press <b>←</b> or <b>→</b> to select <b>Slide Show</b> , <b>Contents</b> , or <b>Memory Stick</b> . <b>3</b> Press <b>↑</b> or <b>↓</b> to select the option you want to change. For details on these options, see “Memory Stick Index Menu Bar Options” on page 88.
Move the highlight from the Memory Stick Menu bar back to the thumbnails	<b>1</b> Press <b>←</b> or <b>→</b> to select <b>▼</b> . <b>2</b> Press <b>↑</b> to return to the currently displayed thumbnails, or <b>↓</b> to display the next page of thumbnails.
Exit Memory Stick Viewer	Press <b>🏠/F1</b> button on the remote control.

## Viewing Photos

When you select a photo from the Memory Stick Index (described on page 81), it displays as shown below, with the following controls.

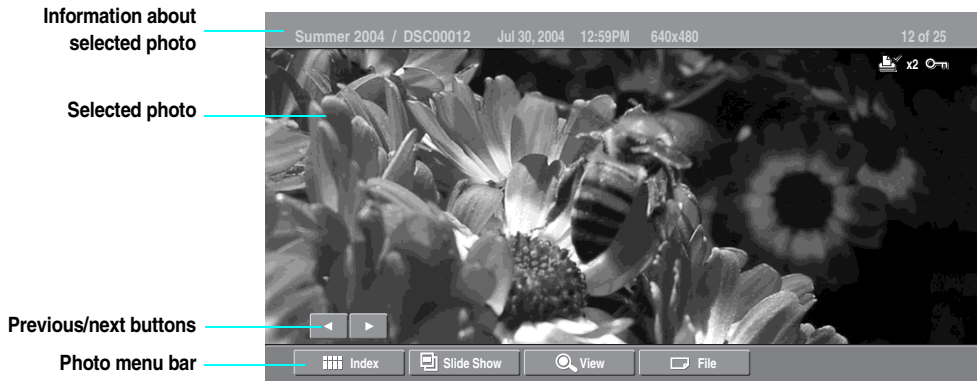

 JPEGs captured using a digital video camera may appear to display motion in full screen. This is a result of the way digital video cameras record still images, and is not a result of a malfunction with the LCD projection TV.

## Photo Controls

 When the menu is hidden, press ◀ or ▶ to go to the previous or next photo.

To Do This ...	Do This ...
Display the next or previous file on the Memory Stick	Press ▲ or ▼ to highlight the ◀▶ (Previous/Next) button. Then press ◀ to go to the previous file, or ▶ to go to the next file.
Hide the Photo menu bar, displaying only the photo	With the highlight in the Photo menu bar, press ▼.
Display the hidden Photo menu bar	Press ▲.
Play the JPEG voice memo (🗣️ files only)	Highlight ▶ (Play) and then press (+). To pause the voice memo, highlight    (Pause) and then press (+).
Display the Memory Stick Index again	Press ◀ or ▶ to highlight <b>Index</b> in the Photo menu bar and press (+). For details on the Memory Stick Index, see page 82.
Access additional options in the Photo menu bar	See “Photo Menu Bar Options” on page 84.
Exit Memory Stick Viewer	Press  /F1 button on the remote control.



## Photo Menu Bar Options

The Photo menu bar lets you access additional photo viewing options.

### To access the Photo menu bar

- 1 Press **←** or **→** to select **Slide Show**, **View**, or **File**.
- 2 Use **↑** **↓** **←** **→** to select the desired option.

Option	Description	
Index	Displays the Memory Stick Index, with the highlight on the currently displayed photo's thumbnail. For details, see "Using the Memory Stick Index" on page 81.	
Slide Show	Displays the Slide Show menu. For details, see "Slide Show Menu Options" on page 88.	
View	<b>Rotate</b>	Allows you to rotate the photo in 90 degree increments clockwise or counterclockwise. For details, see "Using Rotate" on page 85.
	<b>Zoom/Pan</b>	Allows you to magnify and pan across the photo. For details, see "Using Zoom and Pan" on page 85.
File	<b>Protect</b>	Allows you to protect the JPEG file from any changes. When a JPEG file is protected, it cannot be rotated or deleted. Select <b>On</b> or <b>Off</b> .
	<b>Print Quantity</b>	Allows you to indicate the number of prints to make of the specific photo when the Memory Stick is inserted into a compatible photo printer (not supplied).
	<b>Delete</b>	Deletes the JPEG file from the Memory Stick. You cannot delete a JPEG file that has been protected (or if the Memory Stick is locked).

 JPEG files that are protected are indicated by the Lock  icon.

 The **Print Quantity** feature is also known as DPOF (Digital Print Order Format).



## Using Zoom and Pan

### To Zoom and Pan a photo

- 1 In the Photo menu bar, press ◀ or ▶ to highlight **View**.
- 2 Press ▲ or ▼ to highlight **Zoom/Pan** and press (+).
- 3 Specify the zoom center point by using ▲ ▼ ◀ ▶; then press (+) to set the center.

The Zoom and Pan controls are displayed.



#### To Do This ...

Zoom in (increase magnification) or out (decrease magnification)

Pan (left, right, up, down)

Exit the Zoom/Pan controls

Exit Memory Stick Viewer

#### Do This ...

Press ◀ or ▶ to highlight **Zoom** and press (+). Then press ▲ to zoom in or ▼ to zoom out.

To stop using Zoom, press (+).

(You can use **Pan** only when the photo is magnified using **Zoom**.)

Press ◀ or ▶ to highlight **Pan** and press (+). Then press ◀ ▶ ▲ ▼ to pan around the photo.

To stop using Pan, press (+).

Press ◀ or ▶ to highlight **Exit** and press (+).

Press /F1 button on the remote control.

## Using Rotate



You cannot rotate a photo that has been protected. see “Protect” on page 87.

### To Rotate a photo

- 1 In the Photo menu bar, press ◀ or ▶ to highlight **View**.
- 2 Press ▲ or ▼ to highlight **Rotate**.
- 3 To rotate clockwise, press ▲ or ▼ to highlight **Clockwise** and press (+).  
To rotate counterclockwise, press ▲ or ▼ to highlight **Counterclockwise** and press (+).

The photo is rotated 90 degrees each time you press (+).

## Playing Movies

When you select a movie from the Memory Stick Index (described on page 81), it displays as shown below, with the following controls.

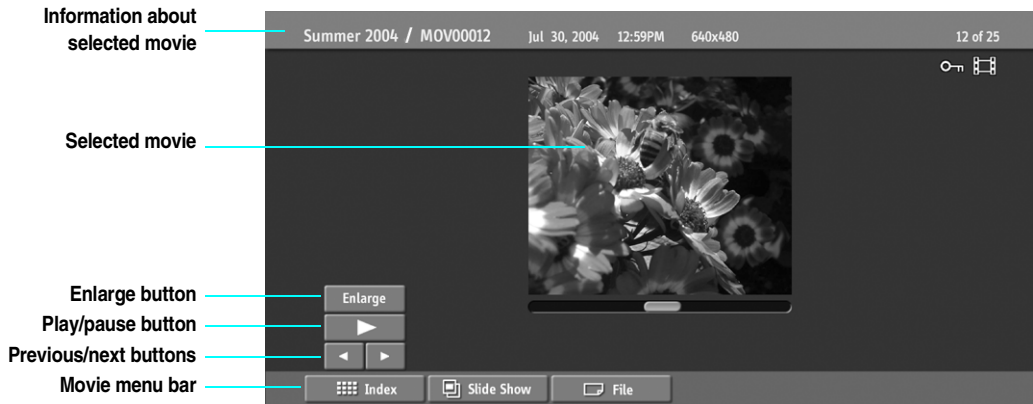

 MPEG movies recorded in VX Fine mode with Sony digital cameras cannot be played back with the Memory Stick Viewer.

### Movie Controls

 The quality of the movie when enlarged depends on the resolution of the MPEG1 file. See your camera's instruction manual for details.

To Do This ...	Do This ...
Enlarge the movie window	Press <b>▲</b> or <b>▼</b> to highlight <b>Enlarge</b> , and then press <b>(+)</b> . To display the movie controls again, press <b>(+)</b> . When the movie playback ends, the movie controls are displayed again.
Play the movie with the movie controls displayed	Press <b>▲</b> or <b>▼</b> to highlight <b>▶</b> (play) and then press <b>(+)</b> .
Pause the movie	While the movie is playing, the <b>▶</b> button changes to the <b>⏸</b> (pause) button. Press <b>▲</b> or <b>▼</b> to highlight <b>⏸</b> (Pause) and then press <b>(+)</b> .
Display the previous or next file on the Memory Stick	Press <b>▲</b> or <b>▼</b> to highlight the <b>◀▶</b> (Previous/Next) button. Then press <b>◀</b> to go to the previous file, or <b>▶</b> to go to the next file.
Hide the Movie menu bar, displaying only the movie	With the highlight in the Movie menu bar, press <b>▼</b> .
Display the hidden Movie menu bar	Press <b>▲</b> .
Access additional options in the Movie menu bar	See "Movie Menu Bar Options" on page 87.
Exit Memory Stick Viewer	Press <b>(Exit)/F1</b> button on the remote control.

## Movie Menu Bar Options

### To access the Movie menu bar

- 1** Use **↑** or **↓** to highlight **Index** in the Movie menu bar.
- 2** Press **←** or **→** to select **Index**, **Slide Show**, or **File**.
- 3** Press **↑** or **↓** to select the desired option.



MPEG1 files that are protected are indicated by the Lock  icon.

<i>Option</i>	<i>Description</i>
<b>Index</b>	Displays the Memory Stick Index, with the highlight on the thumbnail of the currently displayed movie.
<b>Slide Show</b>	Displays the Slide Show menu. For details, see “Slide Show Menu Options” on page 88.
<b>File</b>	<b>Protect</b> Allows you to protect the MPEG1 file from any changes. When an MPEG1 file is protected, it cannot be deleted. Select <b>On</b> or <b>Off</b> .
	<b>Delete</b> Deletes the MPEG1 file from the Memory Stick. You cannot delete an MPEG1 file that has been protected (or if the Memory Stick is locked).

## Memory Stick Index Menu Bar Options

### Slide Show Menu Options



The Slide Show menu is the same whether you select it from the Memory Stick Index (page 81), Photo (page 83), or Movie (page 86) menus.



When you select [Complete List](#), it may take a moment to display the list of all MP3 files.



Some JPEG files may take longer to display than others, which may make it seem longer than the interval you selected for [Slide Advance](#).

The Slide Show menu includes the following options:

Option	Description
<a href="#">Start</a>	Starts the Slide Show.
<a href="#">Music</a>	Allows you to select background audio to play during the Slide Show.
<a href="#">Off</a>	No additional background audio is played during the Slide Show. Audio that is associated with the JPEG or MPEG1 files will play.
<a href="#">Play Memory Stick</a>	Plays all MP3 files on the Memory Stick. The <a href="#">Piano</a> MP3 file is not played.
<a href="#">Piano (Built-in music)</a>	Plays the MP3 file stored in the LCD projection TV's internal memory.
<a href="#">(List of MP3 Files)</a>	Displays a list of all MP3 files found at the top level (root) of the Memory Stick. To show additional MP3 files stored in other folders on the Memory Stick, select <a href="#">Complete List</a> .
<a href="#">Complete List</a>	Displays a list of all available MP3 files. The list is sorted in alphabetical order, grouped by folder.
<a href="#">Transition Effect</a>	Allows you to select an effect to be used when advancing to the next file in the Slide Show.
<a href="#">Slide Advance</a>	Allows you to specify when to advance to the next slide.
<a href="#">Fast</a>	Slide advances after about 3 seconds.
<a href="#">Medium</a>	Slide advances after about 6 seconds.
<a href="#">Slow</a>	Slide advances after about 12 seconds.
<a href="#">Manual Advance</a>	Slide advances only after you press <a href="#">◀</a> or <a href="#">▶</a> .
<a href="#">File Information</a>	Determines whether file information is displayed. Select <a href="#">On</a> or <a href="#">Off</a> .
<a href="#">Repeat</a>	<a href="#">On</a> Slide Show continuously loops. <a href="#">Off</a> Slide Show plays once through all files and ends.

## Folder Menu Options

The Folder menu includes the following options:

Option	Description
<b>Select Folder</b>	Allows you to select different folders to view in the Memory Stick Viewer.
<b>Digital Camera Folders</b>	Selects all folders within the directories defined by the DCF rules used by Sony digital cameras (see page 90). JPEG and MPEG1 files in those directories are recognized even if they do not conform to the DCF file naming rules.
<b>Select a Folder</b>	Allows you to access individual folders on the Memory Stick.
<b>File Order</b>	Allows you to change the order in which the Memory Stick files are displayed.
<b>Date Order</b>	Displays files in chronological order by modification date.
<b>Date Order Reverse</b>	Displays files in reverse chronological order by modification date.
<b>Alphabetical</b>	Displays files in alphabetical order by filename.
<b>Filter</b>	Allows you to selectively display specific file types within the selected folder.
<b>Show Photos and Movies</b>	Displays all readable files.
<b>Show Photos Only</b>	Displays only photo (JPEG) files.
<b>Show Movies Only</b>	Displays only movie (MPEG1) files.
<b>Show All Print Marks</b>	Displays all files marked with the Print Mark feature, regardless of the currently selected folder. For details, see “Print Quantity” on page 84.



The Rotate and Protect functions do not change the file's modification date.

## Memory Stick Menu

The Memory Stick menu displays the current status of the Memory Stick, including total capacity, used capacity, and free capacity.

## Notes on Using Memory Stick Media

---

### **About DCF File Names**

Most Sony brand digital still and video cameras automatically record still photo and movie files using DCF compliant directory and file names.

If you selected the [Digital Camera Folders](#) option, as described on page 89, you might want to have your digital camera's instruction manual handy in order to check how files and directories are organized for your specific model of digital camera.

DCF stands for "Design Rules for Camera File Systems," which are specifications established by the Japan Electronics and Information Technology Industries Association (JEITA: formerly JEIDA).

## Memory Stick Precautions

When using Memory Stick media, follow these precautions:

- ❑ To avoid permanent damage to still image data, do not turn off the LCD projection TV or remove Memory Stick media from the insertion slot while data is being read (as indicated by the Memory Stick indicator light being on).
- ❑ Avoid touching the terminal of Memory Stick media or bringing it into contact with a metal object.
- ❑ Do not drop, bend, or submit Memory Stick media to external shock.
- ❑ Do not disassemble or modify Memory Stick media.
- ❑ Avoid getting liquid on Memory Stick media.
- ❑ Apply labels only within the designated label area.

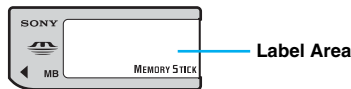

- ❑ To avoid permanent damage to still image data, do not use or store Memory Stick media in a location subject to:
  - High temperature (such as near a heater or inside a hot car)
  - High humidity
  - Direct sunlight
  - Corrosive substances
  - Magnetic fields
  - Excessive dust
  - Static electricity or electric noise
  - Electric surges
- ❑ Store and carry Memory Stick media in its original case to ensure protection of stored data.
- ❑ Save a backup of stored data.
- ❑ When using the Memory Stick Duo, insert it without using the Memory Stick Duo adaptor. For details, see page 79.





# Using the Menus

## Overview

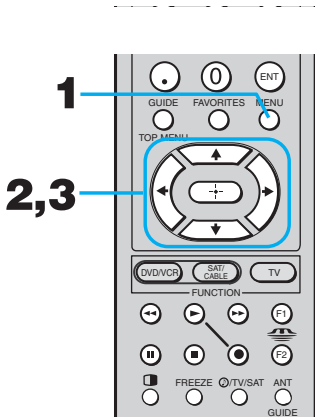

### Opening and choosing a menu

- 1** Press **MENU** to display the menu screen.
- 2** Press **▲** or **▼** to highlight the desired menu icon and press **(+)** to select it.
- 3** Use the arrow buttons to scroll through the features.
- 4** See the specific menu page for instructions on moving through the menu.

### To end a menu session

- Press **MENU** again.

### To end one menu session and move to another

- Press **◀** to return to the menu icons.
- Press **▲** or **▼** to choose the next menu icon and press **(+)** to select it.

### The Menu gives you access to the following features:

Menu Icon	Description	Page
	The Video Menu allows you to make adjustments to your picture settings. It also allows you to customize the Picture Mode based on the type of program you are viewing, select Advanced Video options, and more.	<b>94</b>
	The Audio Menu offers enhanced audio options such as listening to second audio programming (SAP) or customizing the Effect of the sound on your TV.	<b>98</b>
	The Screen Menu allows you to make Wide Mode adjustments and make changes to the screen's vertical center and size.	<b>100</b>
	The Channel Menu allows you to set up a Favorite Channels list, run the Auto Program function, label channels, and more.	<b>102</b>
	The Parent Menu lets you control the viewing of programs based on their ratings.	<b>104</b>
	The Setup Menu provides options for setting up your system, including selecting closed caption modes, labeling video inputs, selecting the language of the on-screen menus, and more.	<b>108</b>
	The Applications Menu lets you display the Memory Stick Viewer, set on/off Timers, access CableCARD and diagnostics information, and more.	<b>111</b>

 Press **MENU** to enter and exit Menus.



## Using the Video Menu

### To select the Video menu

- 1 Press **MENU**.
- 2 Press **▲** or **▼** to highlight the Video icon  and press **(+)**.
- 3 Use the arrow buttons to scroll through the features.
- 4 Press **(+)** to select a feature.
- 5 Use the arrow buttons to make the desired adjustments.
- 6 Press **(+)** to select/set.
- 7 Press **MENU** to exit the menu screen.



### To restore the factory default settings for the Video settings:



- Press **RESET** on the remote control when in the Video menu.

## Selecting Video Options

 To quickly and easily change from one Picture Mode to another, use **PICTURE** on the remote control.

 **Mild Mode** is not available when picture mode is set to **Vivid**.

The Video menu includes the following options.

Option	Description
<b>Mode</b>	<b>Vivid</b> Select for enhanced picture contrast and sharpness.
<i>Customized picture viewing</i>	<b>Standard</b> Select for standard picture settings. Recommended for home entertainment.
	<b>Pro</b> Select to display a picture with minimum enhancements.
	 You can alter the Video menu settings (Picture, Brightness, Color, etc.) for each Mode and each video input.
	 You may set up a “Mode” (Vivid, Standard, Pro) independently for each Video input (Video 1- Video 8, including the Antenna input). Your “Mode” settings are automatically saved after each selection. This allows you to customize the Mode setting for each type of signal source.
<b>Picture</b>	Adjust to increase picture contrast and deepen the color or decrease picture contrast and soften the color.
<b>Brightness</b>	Adjust to brighten or darken the picture.
<b>Color</b>	Adjust to increase or decrease color intensity.
<b>Hue</b>	Adjust to increase or decrease the green tones.
<b>Sharpness</b>	Adjust to sharpen or soften the picture.

Option	Description
<b>Color Temp.</b>	Choose from three color temperatures:
<i>White intensity adjustment</i>	<b>Cool</b> Select to give the white colors a blue tint.
	<b>Neutral</b> Select to give the white colors a neutral tint.
	<b>Warm</b> Select to give the white colors a red tint.
<b>Noise Reduction</b>	Select to reduce the noise level of connected equipment. This also reduces the noise level to and signal from the VHF/UHF jack. Select from <b>High</b> , <b>Medium</b> , <b>Low</b> , <b>Off</b> .
<b>Mild Mode</b>	<b>On</b> Select for a natural, soft picture.
	<b>Off</b> Select to turn off <b>Mild Mode</b> .
	 <b>Mild Mode is unavailable when Mode is set to Vivid.</b>
<b>Power Saving</b>	<b>Standard</b> Select to view picture without the benefit of <b>Power Saving</b> .
	<b>Reduced</b> Select to view picture with reduced power consumption. The picture becomes darker, but also enhances the black level.

Option	Description
Advanced Video	Select <b>Program</b> to choose among the options described below.
<b>DRC Mode</b>	Creates a high-resolution picture with 4 x density, for high quality sources (i.e., DVD player, satellite receiver).
<b>High Density</b>	Recommended for moving pictures.
<b>Progressive</b>	Recommended for still images and text.
<b>CineMotion</b>	Provides an optimized display by automatically detecting film content and applying a reverse 3-2 pulldown process. Moving pictures will appear clearer and more natural-looking.

 **DRC Mode** is not available when watching 480p, 720p, and 1080i sources. Also not available when Mild Mode is On, or when using multi-picture functions (Twin View, Freeze or Memory Stick).

**DRC Palette** Allows you to customize the level of detail (Reality) and smoothness (Clarity) for up to three input sources. For example, you can create one Custom setting to optimize your cable input's picture, and create another to optimize your DVD player's picture. You can switch among the three Custom settings.

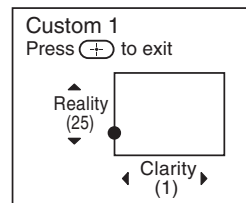

- 1 Press the arrow buttons to highlight **Custom 1**, **Custom 2**, or **Custom 3** and then press . The DRC palette appears.



- 2 Press the arrow buttons to adjust the position of the marker (●). As you move the ● higher along the Reality axis, the picture becomes more detailed. As you move the ● to the right along the Clarity axis, the picture becomes smoother.
- 3 To save the setting, press .

To return the Custom options to the default factory settings, press the **RESET** button.

 **BN Smoother** may not be effective for some connected equipment.

Option	Description
	<p> DRC Palette is not available when watching 480p, 720p, and 1080i sources. Also not available when Mild Mode is On, or when using multi-picture functions (Twin View, Freeze or Memory Stick).</p>
<p><b>BN Smoother</b></p>	<p>Select to reduce noise caused by digital video encoding and decoding process. It is especially effective for watching a DVD or digital TV picture. Select from <b>High</b>, <b>Medium</b>, <b>Low</b> and <b>Off</b>.</p>
	<p> BN Smoother may not be able to correct image quality from some connected equipment.</p>
	<p> BN Smoother is not available when watching 480p, 720p, and 1080i sources, or when using multi-picture functions (Twin View, Freeze or Memory Stick).</p>
<p><b>Live Color</b></p>	<p>Select to enhance the blue and green color. Select from <b>High</b>, <b>Medium</b>, <b>Low</b>, and <b>Off</b>.</p>
<p><b>Clear White</b></p>	<p>Select to emphasize the white colors. Select from <b>On</b> or <b>Off</b>.</p>
<p><b>Detail Enhancer</b></p>	<p>Select to sharpen picture definition. Select from <b>High</b>, <b>Medium</b>, <b>Low</b>, and <b>Off</b>.</p>
<p><b>Black Corrector</b></p>	<p>Select to enhance the black colors to give the picture strong contrast. Select from <b>High</b>, <b>Medium</b>, <b>Low</b>, and <b>Off</b>.</p>
<p><b>Gamma Corrector</b></p>	<p>Select to adjust the balance between bright and dark areas of the picture. Select from <b>High</b>, <b>Medium</b>, <b>Low</b>, and <b>Off</b>.</p>
<p><b>White Balance</b></p>	<p>Select to fine-adjust the white color intensity by changing the red, green and blue levels. Select Adjust to choose among the <b>R-Gain</b>, <b>G-Gain</b>, <b>B-Gain</b>, <b>R-Bias</b>, <b>G-Bias</b>, and <b>B-Bias</b> options. To restore the factory default setting of <b>White Balance</b>, select <b>Initial Set</b>.</p>



## Using the Audio Menu

### To select the Audio menu

- 1 Press **MENU**.
- 2 Press **▲** or **▼** to highlight the Audio icon  and press **(+)**.
- 3 Use the arrow buttons to scroll through the options.
- 4 Press **(+)** to select an option.
- 5 Use the arrow buttons to scroll through the settings.
- 6 Press **(+)** to select the desired setting.
- 7 Press **MENU** to exit the menu screen.



### To restore the factory default settings for Treble, Bass and Balance

- Press **RESET** on the remote control when in the Audio menu.

## Selecting Audio Options

 Virtual Dolby and TruSurround attempt to create the same surround effect produced by a multichannel system using the left and right speakers.

The Audio menu includes the following options:

Option	Description
Treble	Adjust to increase or decrease higher-pitched sounds.
Bass	Adjust to increase or decrease lower-pitched sounds.
Balance	Adjust to emphasize left or right speaker balance.
Steady Sound	Auto Select to stabilize the volume across all programs and commercials.
	Off Select to turn off <b>Steady Sound</b> .
 <b>Steady Sound is not available when Effect is set to Virtual Dolby, TruSurround or Simulated.</b>	
Effect	Virtual Dolby Select for surround sound (for Dolby surround encoded programs only).
	TruSurround Select for surround sound (for stereo programs only).
	Simulated Adds a surround-like effect to mono programs.
	Off Normal stereo or mono reception.

Option	Description	
<b>MTS</b> <i>Enjoy stereo, bilingual and mono programs</i>	<b>Stereo</b>	Select for stereo reception when viewing a program broadcast in stereo.
	<b>Auto SAP</b>	Select to automatically switch to second audio programs when a signal is received. (If no SAP signal is present, the LCD projection TV remains in Stereo mode.)
	<b>Mono</b>	Select for mono reception. (Use to reduce noise during weak stereo broadcasts.)
	 MTS is available only for analog programs.	
<b>Audio Out</b> <i>Easy control of volume adjustments</i>	This option can be set only when the <b>Speaker</b> option is set to <b>Off</b> .	
	<b>Variable</b>	The LCD projection TV's speakers are turned off, but the audio output from your audio system can still be controlled by the LCD projection TV's remote control.
	<b>Fixed</b>	The LCD projection TV's speakers are turned off and the audio output of the LCD projection TV is fixed. Use your audio receiver's volume control to adjust the volume (and other settings) through your audio system.
<b>Speaker</b>	<b>On</b>	Select to turn on the LCD projection TV speakers.
	<b>Off</b>	Select to turn off the LCD projection TV speakers and listen to the TV's sound only through your external audio system speakers.



## Using the Screen Menu

### To select the Screen menu

- 1 Press **MENU**.
- 2 Press **▲** or **▼** to highlight the Screen icon  and press **(+)**.
- 3 Use the arrow buttons to scroll through the features.
- 4 Press **(+)** to select a feature.
- 5 Use the arrow buttons to scroll through the options.
- 6 Press **(+)** to select the desired option.
- 7 Press **MENU** to exit the menu screen.



## Selecting Screen Options

 **Wide Mode** is unavailable while in Twin View (page 68), Freeze (page 73) or Memory Stick mode (page 75).

The Screen menu includes the following options:

Option	Description
<b>Wide Mode</b> <i>Select a screen mode to use for 4:3 sources.</i>	<b>Wide Zoom</b> Select to enlarge the 4:3 picture, to fill the 16:9 screen, keeping the original image as much as possible.
	<b>Normal</b> Select to return the 4:3 picture to its original size and aspect ratio.
	 <b>Normal is not available when watching 720p or 1080i sources.</b>
	<b>Full</b> Select to enlarge the 4:3 picture horizontally only, to fill the wide screen.
	<b>Zoom</b> Select to enlarge the 4:3 picture horizontally and vertically to an equal aspect ratio that fills the wide screen.

 To change from one **Wide Mode** setting to another, use **Wide Mode** on the remote control (see page 56).

**Game Picture** Allows you to move the position of the picture left and right in the window. (This feature also allows you to adjust the picture from any connected equipment.) Select while watching the picture to be adjusted. The LCD projection TV stores the position in memory for each input.

Press **◀** or **▶** to and press **(+)** to choose a correction between +10 and -10.



 If **4:3 Default** is set to anything but **Off**, the **Wide Mode** setting changes only for the current channel. When you change channels (or inputs), **Wide Mode** is automatically replaced with the **4:3 Default** setting. To retain the current **Wide Mode** setting as channels and inputs are changed, set **4:3 Default** to **Off**.

Option	Description	
<b>4:3 Default</b> <i>Select the default screen mode to use for 4:3 sources.</i>	<b>Wide Zoom</b>	Select to enlarge the 4:3 picture, to fill the 16:9 screen, keeping the original image as much as possible.
	<b>Normal</b>	Select to return the 4:3 picture to normal mode.
	<b>Full</b>	Select to enlarge the 4:3 picture horizontally only, to fill the wide screen.
	<b>Zoom</b>	Select to enlarge the 4:3 picture horizontally and vertically to an equal aspect ratio that fills the wide screen.
	<b>Off</b>	Select to continue using the current screen mode setting when the channel or input is changed.
<b>Overscan</b>	<b>Normal</b>	Select to return the default <b>Overscan</b> .
	<b>-1</b>	Select to show more information on screen.
	<b>+1</b>	Select to keep the edge of the picture out of screen.
<b>Vertical Center</b>	<b>Adjust</b>	Allows you to move the position of the picture up and down in the window. (Available only in <b>Wide Zoom</b> and <b>Zoom</b> modes.) Press <b>▲</b> or <b>▼</b> and press <b>(+/-)</b> to choose a correction between +25 and -25 ( <b>Zoom</b> mode), and +10 and -10 ( <b>Wide Zoom</b> mode).
<b>Vertical Size</b>	<b>Adjust</b>	Allows you to adjust the vertical size of the picture. (Available only in <b>Wide Zoom</b> and <b>Zoom</b> modes.) Press <b>▲</b> or <b>▼</b> and press <b>(+/-)</b> to choose a correction between +7 and -7.



## Using the Channel Menu

### To select the Channel menu

- 1 Press **MENU**.
- 2 Press **▲** or **▼** to highlight the Channel icon  and press **↵**.
- 3 Use the arrow buttons to scroll through the features.
- 4 Press **↵** to select a feature.
- 5 Use the arrow buttons to scroll through the options.
- 6 Press **↵** to select the desired option.
- 7 Press **MENU** to exit the menu screen.

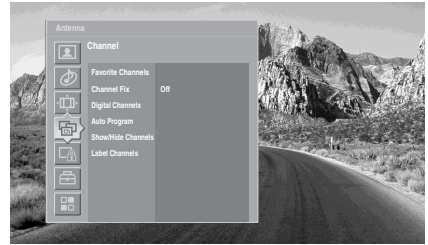



## Selecting Channel Options

The Channel menu includes the following options:

Option	Description
<b>Favorite Channels</b>	Lets you set up a list of your favorite channels. For details, see “Using Favorite Channels” on page 71.
<b>Channel Fix</b>	<b>Off</b> Turns off <b>Channel Fix</b> .
<i>Useful when you have a cable box or satellite receiver connected</i>	<b>2-6</b> “Fix” your LCD projection TV’s channel setting to one channel (2-6) and use the cable box, VCR or satellite receiver to change channels. Select one of these settings if you have connected the device to the VHF/UHF jack.
	<b>C2–C6</b> “Fix” your TV’s channel setting to C2–C6 (CABLE input) and use the cable box or satellite receiver to change channels.
	<b>Video 1</b> Use when connecting a cable box. TV output should be connected through the cable box.
	<b>Video 5</b> Use when connecting a cable box. TV output should be connected through the cable box.
<b>Digital Channels</b>	<b>Add</b> Select to add digital channels.
<b>Auto Program</b>	Automatically sets up the channel list on the TV for all receivable channels for the current input (VHF/UHF or CABLE).
	 <b>Auto Program may take up to 50 minutes to complete. A progress bar will display the approximate progress of the Auto Program and Digital Channels/Add sequences.</b>

 Channels that you set to hide can only be accessed with the 0-9 buttons.

Option	Description
Show/Hide Channels	<p>Allows you to show or hide channels that appear in the Program Guide (see page 64) and when you use the CH+/- buttons to channel surf. Channels that are set to Hidden do not appear in the Program Guide or when you use the CH+/- buttons.</p> <ol style="list-style-type: none"> <li>Press <b>▲</b> or <b>▼</b> to highlight the channel that you want to show or hide.  To move between the Major and Digital subchannel lists, press <b>◀</b> or <b>▶</b>.</li> <li>To change a channel's setting to <b>Shown</b> or <b>Hidden</b>, press <b>(+)</b>.</li> <li>To show or hide more channels, repeat steps 1 and 2.</li> </ol>
<p> If you select to hide or show a major digital channel, all the sub-channels are automatically hidden or shown. To show or hide an individual sub-channel within a digital channel, you must individually select that sub-channel to show or hide.</p> <p> If you hide all sub-channels of a major digital channel, that digital channel is automatically set to Hidden.</p>	
Label Channels	<p>Allows you to assign labels (such as station call letters) to channel numbers.</p> <ol style="list-style-type: none"> <li>Press <b>▲▼</b> to scroll through the channel numbers. Then press <b>(+)</b> to select the channel number that you want to assign a label.</li> <li>Press <b>▲▼</b> to scroll through the label characters (A-Z, 0-9, etc.). Then press <b>(+)</b> to select the highlighted character.  Repeat to add characters to the label.</li> <li>Press <b>◀</b> to return to the Channel menu, or press <b>MENU</b> to exit the menus.</li> </ol>



## Using the Parent Menu

The Parent menu allows you to set up the LCD projection TV to block programs according to their content and rating levels.

### To select the Parent menu

- 1** Press **MENU**.
- 2** Press **▲** or **▼** to highlight the Parent icon  and press **(+)**.
- 3** Use the 0-9 buttons on the remote control to enter a four-digit password.
- 4** If this is the first time you are creating this password, confirm the password by entering it again. (The Parent menu options appear.)
- 5** Press **▲ ▼ ◀ ▶** to change settings. Press **(+)** to select the changed setting.
- 6** Press **MENU** to exit the menu screen.





 You need your password for any future access into the Parent menu. If you lose your password, see “Lost password” on page 121.

## Selecting Parent Options

The Parent menu includes the following options:

Option	Description
<b>Parental Lock</b> <i>Turn ratings on/off and select a rating system</i>	<b>Off</b> Turn Parental Lock off. No programs are blocked from viewing.
	<b>Child</b> Maximum ratings permitted are: US: TV-Y, TV-G, G Canada: C, G, TV-Y
	<b>Youth</b> Maximum ratings permitted are: US: TV-PG, PG Canada: C8+, PG, 8 ans+, TV-PG
	<b>Y. Adult</b> Maximum ratings permitted are: US: TV-14, PG-13 Canada: 14+, 13 ans+, TV-14
	<b>Custom</b> Select to set ratings manually. US: See page 106 for details. Canada: See page 107 for details.

 If you are not familiar with the Parental Guideline rating system, you should select **Child**, **Youth**, or **Y.Adult** to help simplify the rating selection. To set more restrictive ratings, select **Custom**.

 For descriptions of **Child**, **Youth**, and **Y.Adult** ratings, see page 104.

Option	Description
<b>Change Password</b>	Select to change your password.
<b>Select Country</b>	<b>U.S.A.</b> Select to use USA ratings (see page 106). <b>Canada</b> Select to use Canadian ratings (see page 107).

#### To deactivate the parental control feature

- Set **Parental Lock** to **OFF** when in the Parent menu.

#### To change the password

- 1** In the Parent menu, use the arrow buttons to highlight **Change Password**, and press  to select it.
- 2** Enter a new four-digit password using the **0-9** buttons.
- 3** Confirm the new password by entering it again.
- 4** Press **MENU** to exit the menu screen.

## Viewing Blocked Programs

You can view a blocked program by entering the password.

- 1** Press **ENT** when tuned to a blocked program.
- 2** Enter your password using the **0-9** buttons. Parental control will be canceled temporarily until you turn your LCD projection TV off.

## Selecting Custom Rating Options

 To ensure maximum blocking capability, the age-based ratings should be blocked.

 If you select **Block**, be aware that the following programs may be blocked: news, sports, weather, emergency broadcasts, political programs, public service announcements, and religious programs.

### US custom rating options

If you selected U.S.A. as the country of residence on page 105, the Custom Rating menu includes the following options. (If you selected Canada, see page 107.)

Option	Description
<b>Movie Rating</b>	<b>G</b> All children and general audiences.
	<b>PG</b> Parental guidance suggested.
	<b>PG-13</b> Parental guidance for children under 13.
	<b>R</b> Restricted viewing, parental guidance is suggested for children under 17.
	<b>NC-17 and X</b> No one 17 and under.
<b>TV Rating</b> <i>Block programs by their rating, content or both</i>	Age-Based Options
	<b>TV-Y</b> All children.
	<b>TV-Y7</b> Directed to children age 7 and older.
	<b>TV-G</b> General audience.
	<b>TV-PG</b> Parental guidance suggested.
	<b>TV-14</b> Parents strongly cautioned.
	<b>TV-MA</b> Mature audience only.
	Content-Based Options
	<b>FV</b> Fantasy violence.
	<b>D</b> Suggestive dialog.
	<b>L</b> Strong language.
	<b>S</b> Sexual situations.
	<b>V</b> Violence.
<b>Unrated</b> <i>Block programs or movies that are broadcast without a rating</i>	<b>Allow</b> Allows programs and movies that are broadcast without a rating.
	<b>Block</b> Blocks all programs and movies that are broadcast without a rating.

 The content ratings will increase depending on the level of the age-based rating. For example, a program with a **TV-PG V** (Violence) rating may contain moderate violence, while a **TV-14 V** (Violence) rating may contain more intense violence.

**Canadian custom rating options**

If you selected Canada as the country of residence on page 105, the Custom Rating menu includes the following options. (If you selected U.S.A., see page 106.)

<i>Option</i>	<i>Description</i>
English Rating	<b>C</b> All children.
	<b>C8+</b> Children 8 years and older.
	<b>G</b> General programming.
	<b>PG</b> Parental guidance.
	<b>14+</b> Viewers 14 and older.
	<b>18+</b> Adult programming.
French Rating	<b>G</b> General programming.
	<b>8 ans+</b> Not recommended for ages under 8.
	<b>13 ans+</b> Not recommended for ages under 13.
	<b>16 ans+</b> Not recommended for ages under 16.
	<b>18 ans+</b> Programming restricted to adults.
U.S.A. Rating	See “ <b>TV Rating</b> ” on page 106 for details.



## Using the Setup Menu

### To select the Setup menu

- 1 Press **MENU**.
- 2 Press **▲** or **▼** to highlight the Setup icon  and press **↵**.
- 3 Use the arrow buttons to scroll through the features.
- 4 Press **↵** to select a feature.
- 5 Use the arrow buttons to scroll through the options.
- 6 Press **↵** to select the desired option.
- 7 Press **MENU** to exit the menu screen.

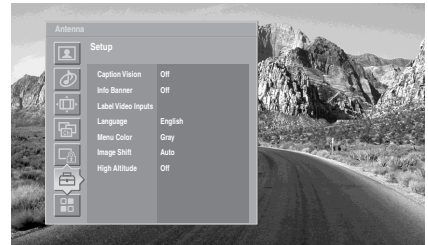

## Selecting Setup Options

The Setup menu includes the following options:

Option	Description	
Caption Vision	Allows you to select from four closed caption modes (for programs that are broadcast with closed captioning).	
	<b>Program</b>	Allows you to set basic and advanced Caption Vision options. See “Programming Caption Vision” on page 110.
	<b>On</b>	Caption Vision is turned on.
	<b>Off</b>	Caption Vision is turned off.
Info Banner	Set to <b>On</b> or <b>Off</b> . When on, displays the program name, time remaining and other information (if the broadcaster offers this service). Displays when the channel is changed or the <b>DISPLAY</b> button is pressed.	

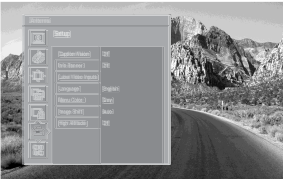
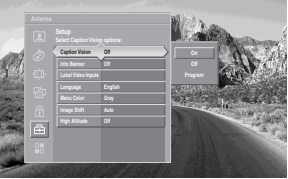
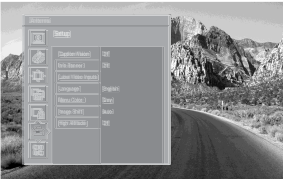
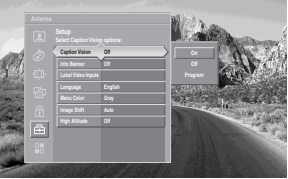
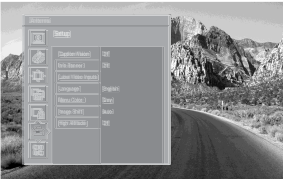
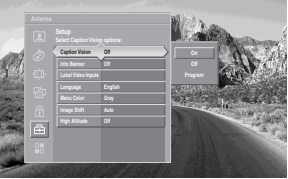

Option	Description				
Label Video Inputs	<p>Allows you to label the audio/video equipment you have connected to the LCD projection TV so you can identify them when using <b>TV/VIDEO</b>. When in this menu:</p> <ol style="list-style-type: none"> <li>Press <b>▲</b> or <b>▼</b> to highlight an input to label, then press <b>(+)</b> to select it.</li> <li>Use the arrow buttons to scroll through the labels.</li> <li>Press <b>(+)</b> to select the equipment you connected to each of the input jacks on the back of your LCD projection TV.</li> </ol> <p>Select <b>Skip</b> if you do not have any equipment connected to a particular input.</p>				
Video 1-4	VHS, DVD, Receiver, Satellite, Cable Box, 8mm, DTV, Game, LD, Beta, Skip				
Video 5-8	DVD, Satellite, Cable Box, DTV, HD, Game, PVR, Skip				
<p> If you select Skip, your LCD projection TV skips the selected connection when you press TV/VIDEO.</p>					
Language	Select to display all on-screen menus in your language of choice: <b>English, Español, Français</b> .				
Menu Color	Enables you to select a specific color for the on-screen menus from <b>Gray, Red, Green, Indigo, Purple, and Translucent</b> .				
Image Shift	Corrects the image on your LCD projection TV.				
<table border="0"> <tr> <td data-bbox="622 1008 911 1031">Before adjusting</td> <td data-bbox="951 1008 1245 1031">After adjusting</td> </tr> <tr> <td data-bbox="628 1060 911 1239"></td> <td data-bbox="958 1060 1245 1239"></td> </tr> </table>		Before adjusting	After adjusting		
Before adjusting	After adjusting				
					
Auto	(Factory setting) Automatically corrects double images.				
Level 1-4	Select a level from 1-4 to align the images and improve the picture.				
High Altitude	<p><b>On</b> Select to use the LCD projection TV at an altitude of 5,000 feet (1,500 m) or higher.</p> <p><b>Off</b> Select to use the LCD projection TV at normal altitude.</p>				

## Programming Caption Vision

If you selected the **Program** option under **Caption Vision** (see page 108), you can change the following settings:

Option	Description
<b>Basic</b>	Allows you to select basic analog (EIA-608) closed caption options.
<b>CC1, CC2, CC3, CC4</b>	Displays a printed version of the dialog or sound effects of a program. (Should be set to <b>CC1</b> for most programs.)
<b>Text1, Text2, Text3, Text4</b>	Displays network/station information presented using either half or the whole screen (if available). For closed captioning, set to <b>CC1</b> .
<b>Advanced</b>	Allows you to select advanced digital (EIA-708) closed caption options. Select from the available options.
<b>Digital CC</b>	Allows you to set digital closed captioning to <b>Basic</b> (digital EIA-608) or <b>Advanced</b> (digital EIA-708).
<b>Advanced Settings</b>	Allows you to make additional settings for digital (EIA-708) closed caption options.
<b>As Broadcast</b>	
<b>Small Text</b>	
<b>Large Text</b>	
<b>Custom...</b>	Allows you to customize the following settings:
<b>Character Size</b>	<b>Small, Standard, Large</b>
<b>Character Style</b>	<b>Style 1-7</b>
<b>Character Color</b>	<b>None, Color 1-8</b>
<b>Edge Color</b>	<b>Color 1-8</b>
<b>Edge Type</b>	<b>None, Raised, Outline, Left shadow, Right shadow</b>
<b>Background Color</b>	<b>None, Color 1-8</b>
<b>Window Color</b>	<b>None, Color 1-8</b>
 <b>Color options can also be set to Solid or Translucent.</b>	



## Using the Application Menu

### Selecting Application Options

#### To select the Application menu

- 1** Press **MENU**.
- 2** Press **▲** or **▼** to highlight the Application icon  and press **(+)**.
- 3** Use the arrow buttons to scroll through the features.
- 4** Press **(+)** to select a feature.
- 5** Use the arrow buttons to scroll through the options.
- 6** Press **(+)** to select the desired option.
- 7** Press **MENU** to exit the menu screen.



Option	Description	Displays...
Memory Stick	Start	Displays the Memory Stick Viewer. For details, see page 82.
Clock/Timers	Select to set the clock and to program your LCD projection TV to turn on and off at two scheduled viewing times.	
	Sleep	Allows you to select the amount of time (15 minutes, 30 minutes, 45 minutes, 60 minutes, 90 minutes or Off) that you want the LCD projection TV to remain on before shutting off automatically.
	Timer 1 Timer 2	You can use the Timers to program the LCD projection TV to turn on and off and tune to a specific channel at two scheduled viewing times.

Option	Description	Displays...
	<p><b>Timer 1</b> and <b>Timer 2</b> cannot be set until you set the <b>Current Time</b>.</p> <p><b>1</b> Press <b>▲</b> or <b>▼</b> to highlight <b>Timer 1</b> or <b>Timer 2</b>. To set the timer, press <b>➔</b>.</p>	
	<p> To go directly to programming <b>Timer 1</b> or <b>2</b>, press <b>⊕</b> instead of pressing <b>➔</b>.</p>	
	<p><b>2</b> Press <b>▲</b> or <b>▼</b> to highlight one of the following options, then press <b>⊕</b>.</p> <p><b>Program</b> Select to set the Timer by day, time, duration, and channel.</p> <p><b>Off</b> Select to turn off the Timer. (Your previous settings are saved.)</p>	
	<p><b>3</b> If you selected <b>Program</b> in step 2, press <b>▲</b> and <b>▼</b> to set the day(s), hour, minute, duration, and channel number. Press <b>⊕</b> or press <b>➔</b> to confirm each setting and move to the next setting.</p> <p>Press <b>◀</b> to go back to the previous setting.</p>	
	<p><b>4</b> Press <b>MENU</b> to exit the menu screen. An LED on the front panel will light, indicating the Timer has been set.</p>	
	<b>Current Time</b>	You can set the current time.
	<p><b>1</b> Press <b>⊕</b> to select <b>Current Time</b>.</p> <p><b>2</b> Press <b>▲</b> and <b>▼</b> to set the current time (day, hour, minute, and AM/PM). Press <b>⊕</b> (or press <b>➔</b>) to confirm each setting and move to the next setting. Press <b>◀</b> to go back the previous setting.</p> <p><b>3</b> Press <b>MENU</b> to exit the menu screen.</p>	
<b>Diagnostics</b>	Display diagnostics information about the TV. This can be useful in providing information to an authorized technician or repair person.	
<b>CableCARD</b>	This list of selectable CableCARD options will vary, depending on your cable service provider.	
<b>Live Color Demo</b>	This is the Demo Mode. If you enter Demo, press <b>RESET</b> button to exit it.	

# Other Information

## Overview

This chapter includes the following topics:

<i>Topic</i>	<i>Page</i>
Glossary	114
Contacting Sony	115
Troubleshooting	115
Flashing Indicators on the Front of the TV	122
Specifications	123
Optional Accessories	125
Index	127

## Glossary

**analog signal**

A signaling method that uses continuous changes in the amplitude or frequency of an electronic transmission to convey information.

**aspect ratio**

Refers to the ratio between the width and height of the screen. This LCD projection TV has a 16:9 (widescreen) aspect ratio, as opposed to a 4:3 aspect ratio.

**4:3 aspect ratio**



**16:9 aspect ratio**



**Cable CARD**

The PCMIA shaped card provided by your cable TV company which descrambles the digitally encrypted cable channels. You should check with your local cable TV company about Cable CARD service.

**component video**



Component video is sent through three cables: two color shade (chrominance) signals and one brightness (luminance) signal. Component video achieves greater color accuracy than composite video or S VIDEO by splitting chrominance into two separate portions.

**composite video**



Composite video is sent through a single cable. Composite video combines the color shade (chrominance) and brightness (luminance) information into one video signal.

**digital television (DTV)**

A new technology for transmitting and receiving broadcast television signals. DTV provides higher resolution and improved sound quality over analog television.

**HDMI (High-Definition Multimedia Interface)**

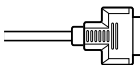

Provides an uncompressed, all-digital audio/video interface between this TV and any HDMI-equipped audio/video component, such as a set-top box, DVD player, and A/V receiver. HDMI supports enhanced, or high-definition video, plus multi-channel digital audio.

**National Television System Committee (NTSC)**

A unit of the Federal Communications Commission, Washington, DC, that establishes television standards in the United States, such as NTSC Color, the standard used in this LCD projection TV.

**RF**

Radio Frequency. That part of the frequency spectrum that is used to transmit TV and radio signals.

**S VIDEO**



S VIDEO requires a single cable, which carries the brightness (luminance) and color (chrominance) signals of the picture separately. S VIDEO provides better resolution than composite video, which carries the signals together.

**VHF/UHF**

VHF (Very High Frequency) is the part of the frequency spectrum from 30 to 300 megahertz. UHF (Ultra High Frequency) is the part of the frequency spectrum from 300 to 3,000 megahertz.

**480i**

Provides 480 lines of resolution. Displays images using interlaced scanning, which first transmits all the odd lines on the LCD projection TV screen and then the even lines.

**480p**

Provides 480 lines of resolution. Displays images using progressive scanning, which transmits each line from top to bottom.

**720p**

Provides 720 lines of resolution. Displays images using progressive scanning, which transmits each line from top to bottom.

**1080i**

Provides 1080 lines of resolution. Displays images using interlaced scanning, which first transmits all the odd lines on the LCD projection TV screen and then the even lines. 1080i is one of the formats used by HDTV (High Definition TV).

## Contacting Sony

If, after reading these operating instructions, you have additional questions related to the use of your Sony television, please call our Customer Information Services Center at 1-800-222-SONY (7669) (US residents only) or 1-877-899-SONY (7669) (Canadian residents only).

Before calling Sony customer support, please write down the model and serial numbers of your TV. You'll find this information on the front cover of this manual.

## Troubleshooting

### Twin View

Problem	Possible Remedies
I cannot get Twin View to work	<ul style="list-style-type: none"> <li>❑ If you are using a cable box to unscramble all channels (as shown on page 32), you cannot use the Twin View feature. This is because the cable box can unscramble only one channel at a time.</li> <li>❑ You can use Twin View to view a signal from a different source that is connected to the LCD projection TV's A/V jacks (such as a VCR or DVD player) in the second window by pressing <b>TV/VIDEO</b> while in Twin View.</li> <li>❑ Sources connected to the CABLE, VIDEO 5, VIDEO 6, VIDEO 7 and VIDEO 8 inputs, as well as digital source display only in the left Twin View window.</li> </ul>
There is no Twin View window, or it is just static	<ul style="list-style-type: none"> <li>❑ Be sure the Twin View window is set to a video input or channel that has a signal airing.</li> <li>❑ You might be tuned to a video input with nothing connected to it. Try cycling through the video inputs by pressing <b>TV/VIDEO</b>.</li> </ul>
Twin View cannot display anything but TV channels	<ul style="list-style-type: none"> <li>❑ Try cycling through the video inputs by pressing <b>TV/VIDEO</b>. Check that the <b>Label Video Inputs</b> option is not set to <b>Skip</b>. (See the Setup menu on page 109.)</li> </ul>
Twin View displays the same program in both windows	<ul style="list-style-type: none"> <li>❑ Both Twin View windows might be set to the same channel. Try changing channels in either window.</li> </ul>

## Remote Control

<b>Problem</b>	<b>Possible Remedies</b>
Remote control does not operate	<ul style="list-style-type: none"><li>❑ The batteries could be weak. Replace the batteries.</li><li>❑ Check the orientation of the batteries.</li><li>❑ Press <b>TV FUNCTION</b> once, and the TV indicator lights up. You may have inadvertently pressed <b>SAT/CABLE FUNCTION</b>, which changes the remote control to SAT or CABLE mode.</li><li>❑ Make sure this unit's power cord is connected securely to the wall outlet.</li><li>❑ Locate the unit at least 3-4 feet away from fluorescent lights.</li></ul>
Cannot change channels with the remote control	<ul style="list-style-type: none"><li>❑ If you are using the LCD projection TV to change channels, first press <b>TV FUNCTION</b> once, and the TV indicator lights up.</li><li>❑ If you are using another device to change channels, be sure you have not inadvertently switched your LCD projection TV from the channel 3 or 4 setting. Use the <b>Channel Fix</b> option to "fix" the channel based on the hookup you used (see page 102).</li><li>❑ If you are using another device to change channels, be sure to press <b>FUNCTION</b> for that device. For example, if you are using your cable box to change channels, be sure to press <b>SAT/CABLE FUNCTION</b> once, and the SAT/CABLE indicator lights up.</li></ul>
Remote control does not operate non-Sony video equipment	<ul style="list-style-type: none"><li>❑ If you replaced the batteries to the remote recently, the code numbers for the video equipment may need to be reset.</li><li>❑ There may be more than one code for the equipment that you are attempting to operate.</li><li>❑ There is a possibility that some non-Sony equipment cannot be operated by your Sony LCD projection TV remote. You may need to use the equipment's original remote control.</li></ul>

## CableCARD

<b>Problem</b>	<b>Possible Remedies</b>
Problems using CableCARD or CableCARD services	<ul style="list-style-type: none"><li>❑ Check that the CableCARD is inserted properly (see pages 52-53).</li><li>❑ The CableCARD must be activated by your local cable TV provider before you can receive digital cable TV services. See the activation instructions on pages 52-53.</li><li>❑ Check the <b>Diagnostics</b> and <b>CableCARD</b> menu options (see page 112). (This can be useful in providing information to an authorized technician or repair person.)</li><li>❑ Contact your cable TV provider.</li></ul>







## Memory Stick

Problem	Possible Remedies
Image does not display/Cannot see all files	<ul style="list-style-type: none"> <li>❑ Some variations of MPEG1 movies may not play back correctly.</li> <li>❑ Make sure the image file is a JPEG (.jpg, .jpeg) file or an MPEG1 (.mpg, .mpeg) file.</li> <li>❑ Make sure the Memory Stick is inserted properly (see page 75).</li> <li>❑ Check the <a href="#">Filter</a> option setting (see page 89).</li> <li>❑ Check the <a href="#">Select Folder</a> setting (see page 89) and ensure that files are either in DCF directories if <a href="#">Digital Camera Folders</a> is selected (see page 89), or in the currently selected folder if <a href="#">Select a Folder</a> is selected (see page 89).</li> <li>❑ The maximum number of files the Memory Stick Viewer can display is 2,000 files total, including all JPEG, MPEG1, and MP3 files.</li> </ul>
JPEG image displays undesirable motion or flicker in full screen	<ul style="list-style-type: none"> <li>❑ JPEGs captured using a digital video camera may appear to display motion in full screen. This is a result of the way digital video cameras record still images, and is not a result of a malfunction with the LCD projection TV.</li> </ul>
Rotation not saved after Memory Stick is ejected or Memory Stick Viewer is closed	<ul style="list-style-type: none"> <li>❑ The Memory Stick might be locked. Unlock the Memory Stick and try rotating the image again.</li> <li>❑ The file might not have information (EXIF data) that is usually generated when a digital camera records a photo. In this case, it is not possible to save the rotation.</li> <li>❑ There might be insufficient space on the Memory Stick to save the rotated file. Try deleting one or more files and rotating the image again.</li> </ul>
Cannot show (or hide) file information in full screen or Slide Show	<ul style="list-style-type: none"> <li>❑ Set the <a href="#">File Information</a> option to <a href="#">On</a> or <a href="#">Off</a> (see page 88).</li> </ul>
Cannot see menu	<ul style="list-style-type: none"> <li>❑ Press <a href="#">▲</a> to display the menu again.</li> </ul>
Cannot hear audio while using Memory Stick	<ul style="list-style-type: none"> <li>❑ Check the LCD projection TV's volume or <a href="#">Speaker</a> (see page 99) settings.</li> <li>❑ To hear JPEG voice memo, select the <a href="#">Digital Camera Folders</a> option and set the <a href="#">Filter</a> option to <a href="#">Show All Print Marks</a>.</li> <li>❑ Check that the <a href="#">Music</a> option is not set to <a href="#">Off</a> (see page 88).</li> </ul>
Not all MP3 files on Memory Stick are included when the <a href="#">Music /Complete List</a> option is selected (page 88)	<ul style="list-style-type: none"> <li>❑ The Memory Stick Viewer can display a maximum of 2,000 files total, including all JPEG, MPEG1, and MP3 files.</li> <li>❑ Make sure that the file is named with the file extension (.mp3).</li> </ul>
MP3 files on the Memory Stick are not listed	<ul style="list-style-type: none"> <li>❑ Only MP3 files that are named with the file extension (.mp3) are displayed in the list.</li> </ul>
Music files are playing in wrong order	<ul style="list-style-type: none"> <li>❑ MP3 files are played in alphabetical order, according to the folder in which they are stored. If you want to change the playlist order, rename your files alphabetically in the order in which you want them to play or create a MP3 playlist (.m3u file) on a PC.</li> </ul>
Cannot see MP3 list to play music	<ul style="list-style-type: none"> <li>❑ MP3 files on your Memory Stick only can be played as background music during a Slide Show (see page 87).</li> </ul>
MPEG1 movie does not play back correctly	<ul style="list-style-type: none"> <li>❑ Some variations of MPEG1 movies may not be compatible with the Memory Stick Viewer.</li> <li>❑ MPEG movies recorded in VX Fine mode with Sony digital cameras cannot be played back with the Memory Stick Viewer.</li> </ul>

(Continued)

## Other Information

<b>Problem</b>	<b>Possible Remedies</b>	
MPEG1 quality is poor when enlarged (page 86)	<input type="checkbox"/>	The quality of the movie when enlarged depends on the resolution of the MPEG1 file. See your camera's instruction manual for details.
Error message is displayed	<input type="checkbox"/>	No Memory Stick There is no Memory Stick in the slot.
	<input type="checkbox"/>	Memory Stick is Locked The lock mechanism on the Memory Stick is engaged.
	<input type="checkbox"/>	Memory Stick Error The Memory Stick in the slot might be damaged; try a different Memory Stick.
	<input type="checkbox"/>	Format Error The Memory Stick may have been formatted using a PC or other device that is not compatible with cameras.
Error icon is displayed		The file is not a valid MPEG1 or JPEG format, or it is a progressive JPEG (which is not supported).
		The thumbnail is not DCF-compatible.
		The file is a JPEG or an MPEG1, but the thumbnail is unreadable.
		The file is unreadable.

## Video

Problem	Possible Remedies
No picture (screen not lit), no sound	<ul style="list-style-type: none"> <li>❑ If your LCD projection TV does not turn on, and a red light keeps flashing, your LCD projection TV may need service. Call your local Sony Service Center.</li> <li>❑ Make sure the power cord is plugged in.</li> <li>❑ Press <b>POWER</b> on the front of the LCD projection TV.</li> <li>❑ Press <b>TV/VIDEO</b> to cycle through the connected video sources.</li> <li>❑ Try another channel; it could be station trouble.</li> </ul>
Dark, poor or no picture (screen lit), good sound	<ul style="list-style-type: none"> <li>❑ Adjust the <b>Picture</b> option in the Video menu (see page 94).</li> <li>❑ Adjust the <b>Brightness</b> option in the Video menu (see page 94).</li> <li>❑ Check the antenna/cable connections.</li> </ul>
No color/dark picture/color is not correct	<ul style="list-style-type: none"> <li>❑ Adjust the <b>Color</b> option in the Video menu (see page 94).</li> </ul>
Only snow and noise appear on the screen	<ul style="list-style-type: none"> <li>❑ Check the antenna/cable connections.</li> <li>❑ Try another channel; it could be station trouble.</li> <li>❑ Press <b>ANT</b> to change the input mode (see page 57).</li> </ul>
Dotted lines or stripes	<ul style="list-style-type: none"> <li>❑ Adjust the antenna.</li> <li>❑ Move the LCD projection TV away from noise sources such as cars, neon signs, or hair-dryers.</li> </ul>
Double images	<ul style="list-style-type: none"> <li>❑ Using a highly directional outdoor antenna or a cable may solve the problem.</li> <li>❑ Set the <b>Image Shift</b> to an appropriate value. The default setting is <b>Auto</b>. If doubled images appear with <b>Auto</b>, select the best value from <b>1</b> to <b>4</b> (see page 109).</li> </ul>
“Black box” on screen	<ul style="list-style-type: none"> <li>❑ You have selected a text option in the Setup menu and no text is available. (See page 108 to reset Setup selections.) To turn off this feature, set the <b>Caption Vision</b> option to <b>Off</b>. If you were trying to select closed captioning, select <b>CC1</b> instead of <b>Text 1-4</b>.</li> </ul>
Black bands appear at the top and bottom of the screen	<ul style="list-style-type: none"> <li>❑ Some wide-screen programs are filmed in aspect ratios that are greater than 16:9 (this is especially common with theatrical releases). Your LCD projection TV will show these programs with black bands at the top and bottom of the screen. For more details, check the documentation that came with your DVD (or contact your program provider).</li> </ul>
Certain programs on DVD or other digital sources display a loss of detail, especially during fast-motion or dark scenes	<ul style="list-style-type: none"> <li>❑ The compression used by certain digital broadcasts and DVDs may cause your LCD projection TV’s screen to display less detail than usual, or cause artifacts (small blocks or dots, pixelations) to appear on your screen. This is due to your LCD projection TV’s large screen and ability to show very fine detail, and is normal for certain digitally recorded programs. Adjust the reality/clarity in the <b>DRC Palette</b> menu (see page 96) to optimize the picture while viewing these sources.</li> </ul>

## Audio

Problem	Possible Remedies
Good picture, no sound	<ul style="list-style-type: none"><li>❑ Press <b>MUTING</b> so that <b>Muting</b> disappears from the screen (see page 56).</li><li>❑ Make sure the <b>Speaker</b> option is set to <b>On</b> in the Audio menu (see page 99).</li><li>❑ Make sure the <b>MTS</b> option is set to <b>Stereo</b> or <b>Mono</b> (see page 99).</li></ul>
Audio noise	<ul style="list-style-type: none"><li>❑ Communication problems may occur if infrared communication equipment (e.g., infrared cordless headphones) is used near the LCD projection TV. Please use headphones other than infrared cordless headphones. Also, if you use infrared communication equipment other than infrared cordless headphones, move the infrared transceiver away from the LCD projection TV until the noise is eliminated, or move the transmitter and receiver of the infrared communication equipment closer together.</li></ul>
Cannot gain enough volume when using a cable box	<ul style="list-style-type: none"><li>❑ Increase the volume of the cable box using the cable box's remote control. Then press <b>FUNCTION</b> once, and the LCD projection TV indicator lights up and adjust the LCD projection TV's volume.</li></ul>
Sound seems weak or insufficient	<ul style="list-style-type: none"><li>❑ The LCD projection TV's audio might be set to <b>Auto SAP</b> or <b>Mono</b>, when it might be better set to <b>Stereo</b>. In the Audio menu (see page 99), set the <b>MTS</b> setting to <b>Stereo</b>. If already set to <b>Stereo</b>, switch to <b>Mono</b> (which may reduce background noise during weak stereo broadcasts).</li></ul>
Cannot raise the volume on external speakers	<ul style="list-style-type: none"><li>❑ If the <b>Speaker</b> option is set to <b>Off</b> and the <b>Audio Out</b> option is set to <b>Fixed</b> (in order to output the sound to your audio system), use your audio receiver to adjust the sound (see page 99). Or, to use the LCD projection TV remote control, set the <b>Audio Out</b> option to <b>Variable</b>.</li><li>❑ To turn on the LCD projection TV speakers, set the <b>Speaker</b> option to <b>On</b> (see page 99).</li></ul>

## Channels

Problem	Possible Remedies
Cannot receive upper channels (UHF) when using an antenna	<ul style="list-style-type: none"><li>❑ Press <b>ANT</b> to select the VHF/UHF input (see page 57).</li><li>❑ Use <b>Auto Program</b> in the Channel menu to add receivable channels that are not presently in the LCD projection TV's memory (see page 102).</li></ul>
TV is fixed to one channel	<ul style="list-style-type: none"><li>❑ Use <b>Auto Program</b> in the Channel menu to add receivable channels that are not presently in the LCD projection TV's memory (see page 102).</li><li>❑ Check your <b>Channel Fix</b> settings (see page 102).</li></ul>
Cannot receive any channels when using cable TV	<ul style="list-style-type: none"><li>❑ Use <b>Auto Program</b> in the Channel menu to add receivable channels that are not presently in the LCD projection TV's memory (see page 102).</li><li>❑ Press <b>ANT</b> to select the CABLE input (see page 57).</li></ul>
Cannot receive or select channels	<ul style="list-style-type: none"><li>❑ Use <b>Auto Program</b> in the Channel menu to add receivable channels that are not presently in LCD projection TV memory (see page 102).</li></ul>
Some digital cable channels are not being displayed	<ul style="list-style-type: none"><li>❑ Certain cable companies have limitations on the broadcast of digital cable channels. Check with your cable company for more information.</li><li>❑ The digital cable channel may be set to <b>Hidden</b> in the Digital Setup menu (see page 103).</li></ul>

## General

Problem	Possible Remedies
How to reset TV to factory settings	❑ Turn on the TV. While holding down the <b>RESET</b> button on the remote control, press the <b>POWER</b> button on the TV. (The TV will turn itself off, then back on again.) Release the <b>RESET</b> button.
How to restore Video settings to factory settings	❑ Press <b>RESET</b> on the remote control while in the Video menu (see page 94).
How to restore Audio settings to factory settings	❑ Press <b>RESET</b> on the remote control while in the Audio menu (see page 98).
Cannot cycle through the other video equipment connected to the LCD projection TV	❑ Be sure the <b>Label Video Inputs</b> option is not set to <b>Skip</b> (see page 109).
Cannot operate Menu	❑ If a menu option appears in gray, this indicates that the menu option is not available.
Lost password	❑ In the password screen (see page 104), enter the following master password: <b>4357</b> . The master password clears your previous password; it cannot be used to temporarily unblock channels.
TIMER/STANDBY LED on front panel is lit	❑ The LED (see page 22 or 122) blinks when the TV is turned on, then shuts off when the picture is displayed. If the LED blinks continuously, this may indicate the TV needs service. When lit, indicates that the timer is set (see page 22 or 122). When the timer is set, this LED will remain lit even when the TV is turned off.
Digital cable box does not work	❑ If you are connecting a VCR and digital cable box using a splitter, as described on page 36, you must use a special bi-directional splitter that is designed to work with your digital cable box. Contact your cable provider for details.
Cannot record digital channels to VCR	❑ Only analog channels can be recorded to your VCR.
The replacement lamp does not light up	❑ The screw of the lamp cover may be slanted. Take out the screw, insert it straight into the screw hole, and then tighten it completely (see page 16).
TV cabinet creaks	❑ When the TV is in use, there is a natural rise in temperature, causing the cabinet to expand or contract and may be accompanied by a slight creaking noise. This is not a malfunction.

## Flashing Indicators on the Front of the TV

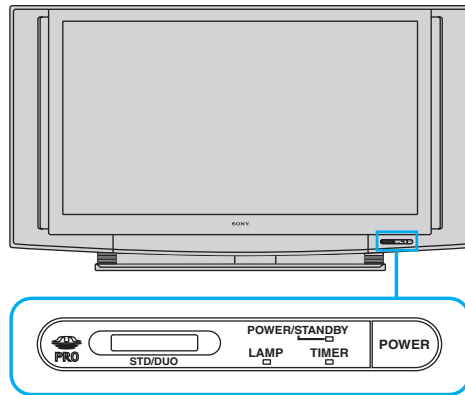

The POWER/STANDBY (green or red) and/or LAMP (red) indicators light or flash if there is a problem with or change in the condition of the LCD projection TV.

**The POWER/STANDBY (green) indicator flashes.**

- The lamp for the light source is ready to turn on.

**The POWER/STANDBY (red) indicator flashes three times.**

- The lamp cover is not attached securely. When you secure the lamp cover, the POWER/STANDBY indicator flashes in red and the LCD projection TV enters the standby mode (see page 22).

**The LAMP indicator flashes.**

- The lamp for the light source has burned out.  
Replace it with new one (see page 16).

If the LCD projection TV does not function properly after correcting the problems, contact qualified Sony personnel.

## Specifications

Projection System	3 LCD Panels, 1 lens projection system	
LCD Panel	0.87 inch TFT LCD panel Approx. 3.28 million dots (1,042,168 pixels)	
Projection Lens	High Performance, large diameter hybrid lens F2.4	
Antenna	75 ohm external terminal for VHF/UHF	
Lamp	UHP lamp, 132W, XL-2200	
Television System	NTSC	American TV Standard
	ATSC (8VSB terrestrial)	ATSC compliant 8VSB
	QAM on cable	ANSI/SCTE 07 2000
Screen Size (measured diagonally)	KDF-55XS955: 55 inches	
	KDF-60XS955: 60 inches	
Channel Coverage	Terrestrial (analog)	2-69
	Cable TV (analog)	1-125
	Terrestrial (digital)	2-69
	Cable TV (digital)	1-135
Power Requirements	120V, 60 Hz	
Inputs/Outputs		
HDMI IN	2 total	Video: 1080i, 720p, 480p, 480i Audio: Two channel linear PCM 32, 44.1 and 48 kHz, 16, 20 and 24 bit
Video (IN)	4 total (1 on front panel)	1 Vp-p, 75 ohms unbalanced, sync negative
S Video (IN)	4 total (1 on front panel)	Y: 1 Vp-p, 75 ohms unbalanced, sync negative C: 0.286 Vp-p (Burst signal), 75 ohms
Audio (IN)	7 total (1 on front panel)	500 mVrms (100% modulation) Impedance: 47 kilohms
Component Video Input	2 (Y, Pb, Pr)	Y: 1.0 Vp-p, 75 ohms unbalanced, sync negative Pb: 0.7 Vp-p, 75 ohms Pr: 0.7 Vp-p, 75 ohms
CONTROL S (IN)	1	minijack
CONTROL S (OUT)	1	minijack
AUDIO (VAR/FIX) OUT	1	500 mVrms at the maximum volume setting (Variable) 500 mVrms (Fixed) Impedance (output): 2 kilohms
		 AUDIO OUT jacks are operable only when the TV's Speaker is set to Off.
RF Inputs	2	
Digital Audio Optical Output (PCM/Dolby Digital)	1	Optical Rectangular (1)
CableCARD Slot	PCMCIA Type I/II	
Speaker Output	5 W (L), 5 W (R), 20 W (Woofer)	

(Continued)

---

## Other Information

Dimensions (W × H × D)	KDF-55XS955: (62 × 37 1/2 × 19 inches) (1,574 × 952 × 484 mm) KDF-60XS955: (66 3/8 × 39 5/8 × 20 1/4 inches) (1,685 × 1,007 × 514 mm)
Mass	KDF-55XS955: 48.0 kg (105 lb 29 oz) KDF-60XS955: 51.5 kg (113 lb 19 oz)
Power Consumption	
In Use	KDF-55/60XS955: 265 W
In Standby	Less than 20 W
Supplied Accessories	
Remote Control	RM-Y915
AA (R6) Batteries	2 supplied for remote control

Design and specifications are subject to change without notice.



## Optional Accessories

- ❑ HDMI cable
- ❑ Component video cable
- ❑ S VIDEO cable
- ❑ A/V cable
- ❑ Audio cable
- ❑ Optical cable
- ❑ Control S cable : RK-G69
- ❑ TV Stand : SU-GW12
- ❑ Lamp : XL-2200



# Index

## Numerics

0-9 buttons **56, 63**

4:3 Defaults **101**

## A

Activating a Twin View screen  
**68**

Adding channels to the channel  
list **103**

Adjusting audio, Steady Sound  
**98**

Advanced Video **96**

Alternate Audio **65**

Alternate Video **65**

ANT button **57, 63**

Antenna, connecting **29, 30**

Audio Menu **93, 98**

Audio Out **99**

Audio receiver, connecting **45**

Auto Program (channel setup) **54,**  
**102**

Auto SAP **99**

## B

Balance, adjusting **98**

Bass, adjusting **98**

Batteries, inserting in remote **55**

Black Corrector **97**

BN Smoother **97**

Brightness, adjusting **94**

## C

Cable

connecting **29, 30**

with VCR, connecting **35**

Cable box

connecting with VCR **36**

using with TV remote control  
**60**

CableCARD **52, 112**

Camcorder, connecting **44**

Caption Vision **108, 110**

CATV. *See cable*

Channel Fix **102**

Channel Menu **93, 102**

Channels

Auto Program **102**

creating labels **103**

channels

setting up **54**

Clear White **97**

Clock/Timers **111**

Closed caption modes **93, 108**

Color temperature, adjusting **95**

Color, adjusting **94**

Connecting

Audio receiver **45**

Cable box **31–32**

Cable and antenna **30**

Cable or antenna **29**

Camcorder **44**

DVD player **42**

Satellite receiver **39–41**

VCR **35–38, 40–41**

CONTROL S **51**

## D

Detail Enhancer **97**

Diagnostics **112**

Digital Channels **102**

Digital subchannels **65**

DISPLAY button **57, 63**

Display unit

controls **22**

Display, turning off **57**

DRC Mode **96**

DRC Palette **96**

DVD player

using with TV remote control  
**61, 62**

with A/V connectors,  
connecting **43**

with component video  
connectors,  
connecting **42**

## E

Effect **98**

Enlarging pictures, in Twin View  
**70**

ENT button **56, 63**

error messages, Memory Stick  
**118**

## F

Favorite Channel

setting up **102**

using **71**

Features **12**

FREEZE button **56**

Freeze, using **73**

FUNCTION button **56**

## G

Game Picture **100**

Gamma Corrector **97**

GUIDE button **56, 64**

Guide menu **65**

## H

High Altitude **109**

Hue, adjusting **94**

## I

Image Shift **109**

Info Banner **108**

Inputs, labeling **109**

Installation of the Projection TV  
**25–27**

interlaced **114**

## J

JUMP button **57, 63**

## L

Label

Channels **103**

video inputs **109**

Lamp, replacing **16–19**

Language **109**

Live Color **97**

Live Color Demo **112**

(Continued)

- M**
- Memory Stick
    - Duo **79**
    - features **75**
    - Index **81**
    - indicator (LED) **22**
    - insertion slot **22**
    - panning photos **85**
    - photo options **84**
    - playing movies **86**
    - precautions **91**
    - removing **80**
    - rotating photos **85**
    - slide show options **88**
    - troubleshooting **117**
    - viewing photos **83**
    - zooming photos **85**
  - MENU button **57, 63**
  - Menu Color **109**
  - Menus
    - Applications **93, 111**
    - Audio **93, 98**
    - Channel **93, 102**
    - Parent **93, 104**
    - Screen **93, 100**
    - Setup **93, 108**
    - Video **93, 94**
    - Mild Mode **95**
  - Mode
    - Pro **94**
    - Standard **94**
    - Vivid **94**
  - MTS/Auto SAP **99**
  - MUTING button **63**
- N**
- Noise Reduction **95**
- O**
- Overscan **101**
- P**
- Parent Menu **93, 104**
  - Parental control, described **12**
  - Parental Lock **104**
  - Password, changing **105**
  - PICTURE button **56**
  - Picture contrast, adjusting **94**
  - Picture size, adjusting in Twin View **70**
- Power Saving **95**
- POWER/STANDBY indicator **22, 122**
- problems, troubleshooting **115–121**
- Program Guide **64**
- Program Options menu **65**
- progressive **114**
- R**
- Ratings
  - setting **106**
  - viewing blocked programs **105**
- Rear panel controls and connections **23**
- Remote control
  - inserting batteries **55**
  - programming **58–59**
- Removing channels from the channel list **103**
- RESET button **56**
- Resetting
  - Audio options **98**
  - Video options **94**
- S**
- Satellite receiver
  - connecting **39**
  - using with TV remote control **60**
- Screen Menu **93**
- setting up channels **54**
- Setup menu **108**
- Sharpness, adjusting **94**
- Show/Hide Channels **103**
- Simulated **98**
- Speaker **99**
- Specifications **123–124**
- Steady Sound
  - adjusting **98**
- T**
- Timer
  - set current **112**
- TIMER indicator **22, 121**
- Timer setting **111**
- Treble, adjusting **98**
- troubleshooting **115–121**
- TruSurround **98**
- TV FUNCTION button **63**
- TV POWER button **57, 63**
- TV/VIDEO button **57, 63**
- Twin View™
  - activating a picture **68**
  - described **12**
  - using **68**
- V**
- VCR
  - using with TV remote control **61**
  - with cable box, connecting **36**
  - with cable, connecting **35**
  - with satellite receiver, connecting **40**
- Vertical Center **101**
- Vertical Size **101**
- Video inputs, labeling **109**
- Video Menu **93, 94**
- Video Modes, selecting **94**
- Viewing area, recommended **27**
- Virtual Dolby **98**
- VOL +/- button **56, 63**
- W**
- White Balance **97**
- Wide Mode **100**
- Wide Screen Mode **66**
- Z**
- Zoom feature, with Twin View **70**

<http://www.sony.net/>

Printed in U.S.A.